

University of Southern Queensland
Faculty of Health, Engineering and Sciences

**“An Investigation into LandXML for
implementation of 3D Cadastre in eSurvey”**



A dissertation submitted by

Robert John Hancock

In fulfilment of the requirements of

Courses ENG4111 and ENG4112 Research Project

Towards the degree of

Bachelor of Spatial Science Honours (Surveying)

Summited: October 2015

Table of Contents

Table of Figures.....	v
Acronyms	vii
Glossary.....	ix
Abstract.....	x
Disclaimer.....	xi
Certification.....	xii
Chapter One.....	1
1 Introduction	1
1.1 Background	1
1.2 Statement of the Problem	2
1.3 Outline of the Study.....	2
1.4 Significance of the Study.....	3
1.5 Aims & Objectives	3
1.6 Organisation of Dissertation	5
1.6.1 Chapter One Introduction.....	5
1.6.2 Chapter Two Literature Review	6
1.6.3 Chapter Three Methodology.....	6
1.6.4 Chapter Four Results.....	6
1.6.5 Chapter Five Conclusions and Future Research.....	6
Chapter Two.....	7
2 Literature Review	7
2.1 Introduction	7
2.2 General Characteristics of eSurvey	8
2.3 General Characteristics of 3D Cadastre and 3D Plans	12
2.3.1 Volumetric Plans	12
2.3.2 Building Plans	14
2.4 General Characteristics of LandXML.....	14
2.5 Industry Standards.....	15
2.5.1 ISO19152	15
2.5.2 ePlan.....	16
2.5 Other Digital Lodgement within ICSM Community.....	18

2.5.1 New South Wales (ePlan).....	18
2.5.2 Victoria (SPEAR)	19
2.5.3 New Zealand (Landonline)	19
2.6 Conclusions	20
Chapter Three	21
3 Methodology.....	21
3.1 Project Methodology	21
3.2 Project Intellectual Property.....	21
3.3 The Study Area	22
3.3.1 Survey Plan I (213499)	22
3.3.2 Survey Plan II (116505)	23
3.4 Validation of 3D Cadastral Data.....	24
3.5 Research Design Framework.....	32
3.5.1 Creation Phase	32
3.5.2 Exporting into LandXML File	32
3.5.3 Rendering and validation Phase of LandXML File.....	33
3.6 Conclusion.....	33
Chapter Four	35
4 Results.....	35
4.1 Summary of Findings.....	35
4.2 Creation Phase	35
4.2.1 Survey Plan I (SP213499)	35
4.2.1.1 CivilCAD	35
4.2.1.2 Trimble Business Centre	39
4.2.1.3 AutoCAD.....	41
4.2.2 Survey Plan II (SP116505)	44
4.2.2.1 CivilCAD	44
4.2.2.2 Trimble Business Centre	46
4.2.2.3 AutoCAD.....	47
4.3 Exporting into LandXML File	50

4.3.1 Survey Plan I (SP213499)	50
4.3.1.1 CivilCAD	50
4.3.1.2 Trimble Business Centre	51
4.3.1.3 AutoCAD	52
4.3.2 SP116505	53
4.3.2.1 CivilCAD	53
4.3.2.2 Trimble Business Centre	54
4.3.2.3 AutoCAD	55
4.4 eSurvey Rendering and Validation Phase	55
4.4.1 Case Studies	55
4.4.1.1 CivilCAD	56
4.4.1.2 Trimble Business Centre	58
4.4.1.3 AutoCAD	59
4.5 Discussion of Results	61
4.6 Conclusions	62
Chapter Five	64
5 Conclusion	64
5.1 Research Aim and Objectives	64
5.1.1 Objective 1	64
5.1.2 Objective 2	65
5.1.3 Objective 3	65
5.1.4 Objective 4	66
5.1.5 Objective 5	66
5.2 Contributions of this Research	67
5.3 Future Research	67
5.3.1 3D Geometric Modelling	67
5.4 Final Conclusions	67
References	68
ENG4111/4112 Research Project	73
Appendix B	74

Table of Figures

Figure 1.1 Survey plan lodgement process.....	3
Figure 1.2 Conceptual design framework.....	4
Figure 1.3 Chapter structure of the dissertation	5
Figure 2.1 eSurvey submit plan process (State of Queensland, 2013b).....	9
Figure 2.2 Phase 2 of eSurvey life cycle (State of Queensland, 2014).....	11
Figure 2.3 Example of volumetric format plan (SP166813).....	13
Figure 2.4 Example of a complex volumetric format plan in isometric format (SP150138).....	14
Figure 3.1 Location map of case study areas.....	22
Figure 3.2 Case study one Volumetric Plan (SP213499).....	23
Figure 3.3 Case study Two Volumetric doughnut(SP116505)	24
Figure 3.4 Harmonised data model showing the package diagram within LandXML data	25
Figure 3.5 ePlan Model Packages (ePlan 2010) showing the RRR's within the LandXML data	26
Figure 3.6 eSurvey services web portal	27
Figure 3.7 Validation rule process flow (State of Queensland, 2013a)	28
Figure 3.8 Validation report layout of eSurvey CIF validation rules	29
Figure 3.9 Showing possible outcomes of expected LandXML	31
Figure 3.10 Stages of the methodology.....	32
Figure 4.1 CivilCAD in 2D view	36
Figure 4.2 CivilCAD and the creation of a line with length	36
Figure 4.3 View of a parcel in 3D	37
Figure 4.4 Imported data of the created object	38
Figure 4.5 Other object created of the Survey Plan.....	38
Figure 4.6 Data exported into LandXML and then imported back into CivilCAD.....	39
Figure 4.7 3D view of the boundary lot	39
Figure 4.8 3D view of the fully closed boundary lot	40
Figure 4.9 Cg_points from imported LandXML file in 3D view	40
Figure 4.10 Case study SP213499 2D view in AutoCAD	41
Figure 4.11 Case study SP213499 3D view in AutoCAD	41
Figure 4.12 Using Civil3D to export and import the LandXML file.....	42
Figure 4.13 2D version with the AutoCAD add on	42
Figure 4.14 Objects represented in 3D Isometric views using different colours.....	43

Figure 4.15 Alternate 3D isometric view	43
Figure 4.16 Imported AutoCAD add on file in 2D	44
Figure 4.17 CgPoints not imported with elevation values.....	44
Figure 4.18 Created attributes of one of the Arc in CivilCAD	45
Figure 4.19 3D viewer unable to view the created parcel	45
Figure 4.20 Created doughnut parcel in CivilCAD.....	46
Figure 4.21 The representation of the LA_BoundaryFaceString in3D view.....	46
Figure 4.22 Surface with points and Lines in 3D view	47
Figure 4.23 Imported LandXML into Trimble Business Centre	47
Figure 4.24 Created file using AutoCAD Civil 3D.....	48
Figure 4.25 view of the Doughnut Parcels.....	48
Figure 4.26 3D view of the central shaft connects with the middle doughnut	49
Figure 4.27 Gaps in between the lots not creating a full boundary	49
Figure 4.28 An unclosed parcel made with AutoCaD add-on	50
Figure 4.29 Error of CgPoints from LadnXMLA4C and edited LandXML file.....	56
Figure 4.30 LandXML data createdfrom AutoCAD.....	60

Acronyms

2D: 2 Dimensional

3D: 3 Dimensional

3DCDB: 3Dimensional Digital Cadastral Data Base

4D: 4 Dimensional

ASCII: American Standard Code for Information Interchange

ATS: Automated Titles Systems

BUP: Building Unit Plan

CIF: Cadastral Information File

CAD: Computer Aided Drawings

CIFs: Cadastral Information Files

CIF: Cadastral Information File

CTS: Community Titles Scheme

DNRM: Department of Natural Resources and Mines

DCDB: Digital Cadastral Data Base

EARL: Electronic Access for Registry Lodgement (in 2015 the project was renamed as eSurvey)

ESRI: Environmental Systems Research Institute

GIS: Geographic Information Systems

GTP: Group Title Plan

EARL: Electronic Access for Registry Lodgement

EARL I: Electronic Access for Registry Lodgement Stage One

EARL II: Electronic Access for Registry Lodgement Stage Two

EARL III: Electronic Access for Registry Lodgement Stage Three

eSurveyIII: Electronic Access for Registry Lodgement Stage Three

ICSM: Intergovernmental Committee Surveying and Mapping

LASSI: Land & Survey Spatial Information

LINZ: Land Information New Zealand

LandXML: Land Extensible Mark-up Language

LADM: Land Administration Domain Model

LPI: Land and Property Information

NZ: New Zealand

NSW: New South Wales

OGC: Open Geo Spatial Consortium

QLD: Queensland

QIF: Queensland Interchange Format

RRR's: Rights, Restrictions and Responsibilities

SPEAR: Surveying and Planning through Electronic Applications and Referrals

SCDB: Survey Control Database

SPDB: Survey Point and Marks Database

SDRN: Survey Database Road Network

SFP: Standard Format Plan

SIP: Surveying Information Processing

PID: Persistent Identifier Database

UML: Unified Modelling Language

XML: Extensible Mark-up Language

Glossary

Geometry: is the main part of the schema and contains geometrical information such as coordinates, parcels and surfaces.

Initialisation: specifies units, coordinate systems and application which is a description about the application that created a LandXML file.

Metadata: is the data about data, which includes some description about the data such as name, version, date and comments.

Survey Data: includes information about the surveying process such as survey observations and metadata of the surveying configuration.

Abstract

With the rapid growth of urban environments including the increasing complexity of infrastructures, there is an urgent need to develop more innovative and efficient land administration systems. Many countries, including Australia, are now developing and implementing three dimensional (3D) cadastral frameworks to address these situations, but capturing and registering these rights within existing systems brings considerable challenges. In Australia, the existing approach of registering 3D rights and storing partial geometry in databases does not support 3D functionalities such as 3D validation, query, visualisation, and manipulation. The existing Digital Cadastral Data Base (DCDB) does not support the storage of 3D data. There is also no digital lodgement of 3D cadastral, and no automated validation (Karki, 2013).

The Intergovernmental Committee of Surveying and Mapping (ICSM) has endorsed LandXML as the national standard for digital lodgement of cadastral plans. LandXML is an extensible mark-up language (XML) package which can be used for exchanging spatial information. In Queensland Surveying information is captured digitally using tools built in-house, such as the Surveying Information Processing (SIP) tool which is based on LandXML and is used to electronically capture a paper based cadastral plans. The Electronic Access for Registry Lodgement (eSurvey, previously called EARL) project is developed and run by the Department of Natural Resources and Mines (DNRM) and it has three stages namely eSurvey-I, eSurvey-II, and eSurvey-III. The eSurvey Services Portal allows users to submit, validate and visualise survey data via Web Services.

eSurvey-I developed a tool for internal DNRM use to digitally capture the information on a survey plan. eSurvey-II has developed a validation tool that will be applied to Cadastral Information Files (CIFs) that are submitted to the Department by external surveyors as a component of the digital lodgement of survey plans process. eSurvey-III will be the full digital lodgement and implementation of electronic capture and visualisation of 3D cadastral data where the digital files become the legal document.

The objective of this research is to explore the capability of LandXML for the definition of 3D spatial objects within the eSurvey project for 3D Cadastre development in Queensland. An overview of 3D Cadastre and characteristics of eSurvey, volumetric plans and LandXML were reviewed. Two representative cases from Queensland digital cadastral database were selected and examined using three standard CAD software and eSurvey web portal and Queensland DCDB standards. This study shows that eSurvey can successfully validate LandXML files.

Disclaimer

University of Southern Queensland

Faculty of Health, Engineering and Sciences

ENG4110, ENG4111 and ENG4112 Research Project

Limitations of Use The council of the University of Southern Queensland, its Faculty of Health, Engineering and Sciences, and the staff of the University of Southern Queensland, do not accept and responsibility for the truth, accuracy or completeness of material contained within or associated with this dissertation.

Persons using all or any part of this material do so at their own risk, and not at the risk of the Council of the University of Southern Queensland, its Faculty of Health, Engineering and Sciences or the staff of the University of Southern Queensland.

This dissertation reports and educational exercise and has no purpose or validity beyond this exercise. The sole purpose of the course pair entitled “Research Project” is to contribute to the overall education within the student’s chosen degree program. This document, the associated hardware, software, drawings, and other material set out in the associated appendices should not be used for any other purpose: if they are so used, it is entirely at the risk of the user.

Dean

Faculty of Health, Engineering and Sciences

Certification

I certify that the ideas, designs and experimental work, results, analysis and conclusions set out in this dissertation are entirely of my own efforts, except where otherwise indicated and acknowledged.

I further certify that the work is original and has not been previously submitted for assessment in any other course or institution, except where specifically stated.

Robert John Hancock

Student number: 0061016455

Signature

Date

Chapter One

1 Introduction

1.1 Background

In 1859, Queensland became a state, and in the same year the Queensland Survey Office was also established. In 1980's, there was major transformation to surveying mapping in Queensland. Significant funding and resources were allocated to develop a digital cadastral Data Base (DCDB) covering Queensland. The first hard copy maps using DCDB data were produced in 1985. Advancements in computer technology allowed a major transformation of operations, production and output of mapping in Queensland (State of Queensland, 2015b). The Queensland Government invested majorly in DCDB development to insure that accuracy was not compromised (State of Queensland, 2015a) and DCDB grew to approximately 2.9 million parcels in 2011.

The Intergovernmental Committee of Surveying and Mapping (ICSM) have imposed national standards known as ePlan. ePlan has been developed using a Unified Modelling Language (UML) class diagram and will be implemented using LandXML and its various schemas and protocols. The Land Administration Data Model (LADM) is a standard model from which the ePlan model can be considered a subset (Karki et al, 2011). As eSurvey continues to use LandXML for its digital lodgement, eSurvey will need to reference ISO/TC211 LADM 19152 in its implementation to comply with the national standards.

As eSurvey is described as “an electronic plan lodgement and validation system developed by LPI (Land and Property Information) that is a faster more secure and more efficient way of processing land title plans” (State of Queensland, 2015a). It is designed to enable the creation and editing of cadastral survey plans within a digital framework. eSurvey is currently in the development and testing stages with the Queensland State Government departments, and is currently in its final stages of the first exposure to industry. When implemented, it will result in a big change to how the cadastre system is used and how license and surveyors will access plans. By using ePlan there are many advantages (Land and Property Information, 2015) which include the ability to:

- lodge plans from anywhere at any time
- reduce third party costs
- eliminate the loss of, or unauthorised changes to plans
- satisfy requisitions online

- finalise quality checks prior to lodgement
- track progress of plans and
- Search a plan's lodgement history.

1.2 Statement of the Problem

There have been some research into the use of LandXML for the implementation of 3D Cadastre, and little research into the scope of eSurvey and the possible limitations of LandXML. Questions have been raised as to whether LandXML is capable of developing 3D cadastre. There is also limited understanding of what LandXML data can be produced by the CAD software's that surveyors are currently using.

In Queensland three different survey plans under the *s.48A (1) Land Title Act 1994{ Queensland, 2014 #61}* are:

- **Standard Format Plan S.48B:** A standard format plan of survey defines land using a horizontal plane and references to marks on the ground.
- **Building Format Plans S.48C:** A building format plan of survey defines land using the structural elements of a building, including, for example, floors, walls and ceilings
- **Volumetric Format Plans S.48D:** A volumetric format plan of survey defines land using 3 dimensionally located points to identify the position, shape and dimensions of each bounding surface

Volumetric format plans are required to describe the boundary surfaces in 3D. This requirement could cause some issues with the suitability of LandXML within eSurvey. As Queensland moves into the implementation of electronic lodgement of survey plans and 3D cadastre the knowledge of this research will give better understanding of LandXML capabilities for developing 3D cadastre.

1.3 Outline of the Study

This project aims to investigate some of the processes which field survey data would undergo through the digital lodgement of eSurvey. In particular, the process includes the conversion of field survey data into LandXML files and projections of 3D spatial objects and storage of CIF (Cadastral Information Files) in a digital cadastral database (DCDB) using eSurvey portal. LandXML is an extension of XML (Extensible Mark-up Language) files. This process can be described into three parts. The first part is using 3 dimensions in regards to the UML process. The second part is creating data by CAD which has been exported into LandXML. The LandXML data has then be used to project 3D modelling using simple shapes and objects and monitor the process with accuracy of the data. The third part is evaluating the level of details in which LandXML could possibly hold.

1.4 Significance of the Study

The lodgement of cadastral plans in Queensland has always been done by a hardcopy plan. This process has been changed much over the history of cadastral plans within Queensland. This can be done in the form of three different plans; volumetric plans, standard plans and building plans. Previous studies have shown that this lodgement process when compared to digital lodgement consumes more time and resources (Wady, 2009). Figure 1.1 illustrates the survey plan lodgement interactions and process in Queensland.

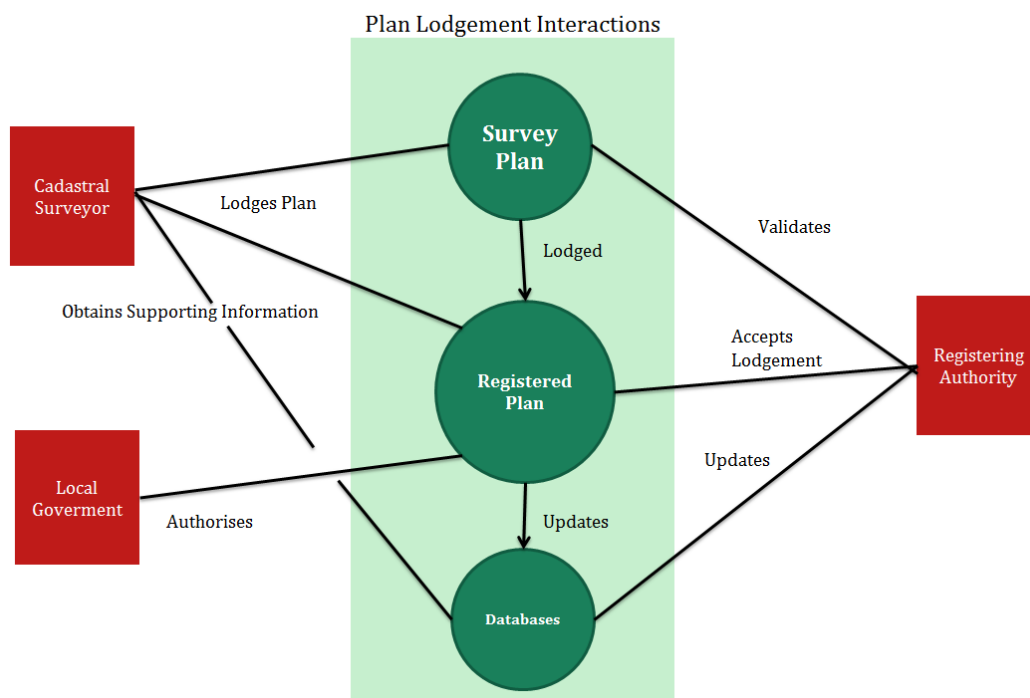

Figure 1.1 Survey plan lodgement process

As Queensland moves towards the use of full digital lodgement for processing, updating and manipulating of cadastral information, the current infrastructure of digital cadastral can become more complex.

1.5 Aims & Objectives

The overall aim of this project is to investigate the ability of LandXML for the definition of 3D spatial objects within the eSurvey project for 3D Cadastre implementation in Queensland.

The following objectives were formulated to investigate some of the scopes and limitations of LandXML within the eSurvey project for 3D Cadastre development in Queensland:

1. Investigate the status of LandXML for digital lodgement within 3D Cadastre in Queensland.
2. Determine the scope and limitations of LandXML in two selected case studies.
3. Explore the limitations of LandXML using current standards within 3D Cadastre.
4. Evaluate current capabilities of CAD software for conversion into LandXML files.
5. Examine the current capabilities of eSurvey for the rendering and validation of LandXML.

Figure 1.2 shows the conceptual design framework of this research.

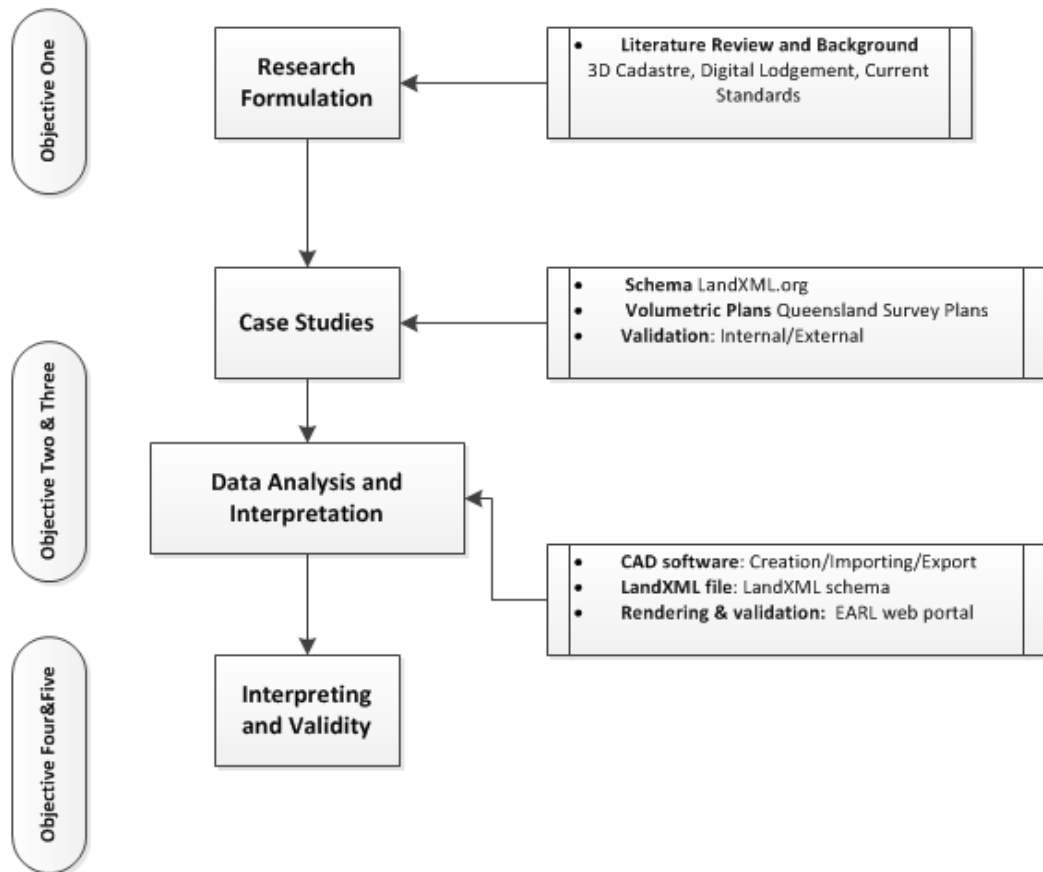

Figure 1.2 Conceptual design framework

The research formulation includes Literature review and identification of the research problem, formulation of research aim and objectives for identification of an appropriate research method. The case study research method has been selected. The scopes and limitations of LandXML and current

capabilities of CAD packages have been explored in the data analysis and interpretation phase. The final step is to examine the current capabilities of eSurvey for the rendering and validation of LandXML.

1.6 Organisation of Dissertation

The structure of the dissertation is shown in Figure 1.3 and organised into Five Chapters. Each Chapter shows the research connection to the objectives so that each objective has been achieved at the end.

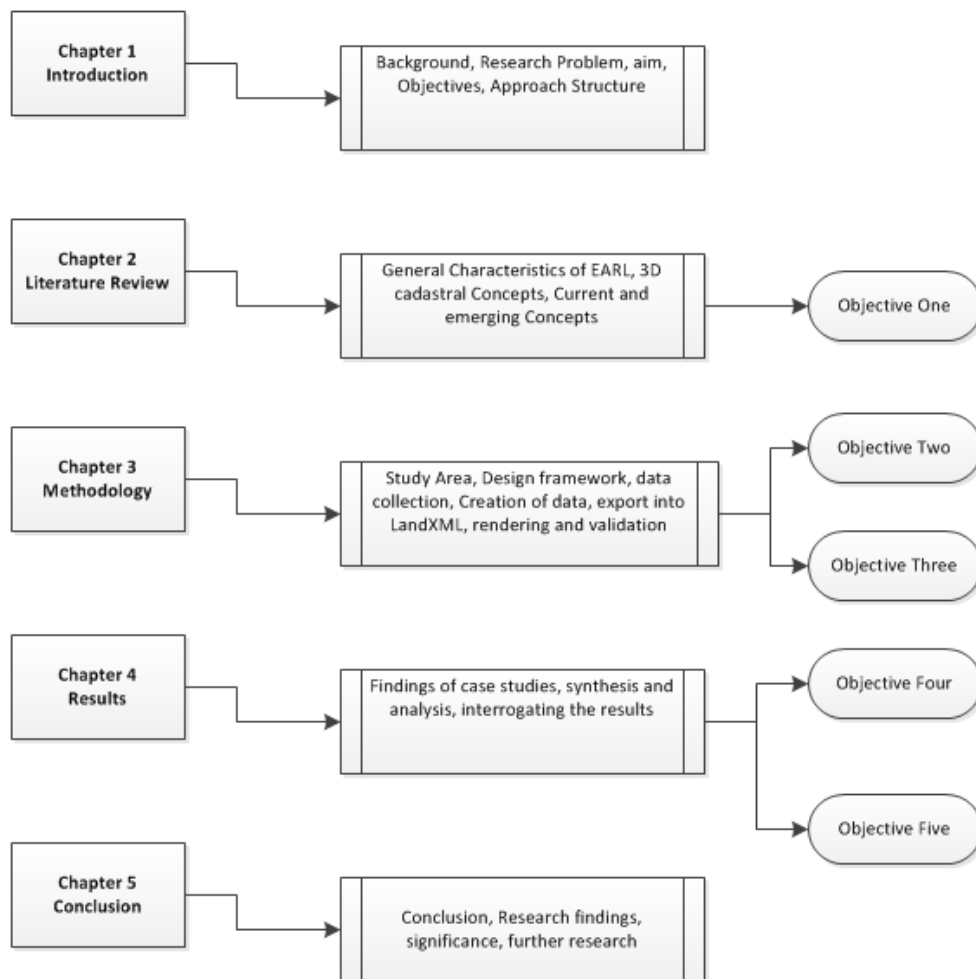

Figure 1.3 Chapter structure of the dissertation

1.6.1 Chapter One Introduction

Chapter One introduces the research background, formulates the research problem and states the research aim and objectives. This Chapter also outlines the dissertation structure.

1.6.2 Chapter Two Literature Review

Chapter two reviews the general characteristics of 3D cadastre, volumetric plan, eSurvey and LandXML. Chapter Two reviews the current standards within spatial industry and discusses the progress of digital lodgement of ePlan with different ICSM jurisdictions.

1.6.3 Chapter Three Methodology

Chapter Three presents the project methodology framework to address the research problem and to achieve the research objectives. The project methodology can be broken into three stages:

Creation Phase -The creation phase is the replication of field survey data and creation of survey plan within Queensland.

Exporting Phase - The exporting phase is the exporting of the CAD data into a LandXML file.

Visualisation Phase - The LandXML data is uploaded onto eSurvey web portal. The eSurvey web portal has been used to render the cadastral information file (CIF) and validate the LandXML data.

1.6.4 Chapter Four Results

Chapter Four documents the results based on the project design framework proposed in methodology.

1.6.5 Chapter Five Conclusions and Future Research

Chapter Five discusses the research achievements and outcomes and any further information that was investigated during this project. This chapter also highlights the significance of findings and suggests directions for future research.

Chapter Two

2 Literature Review

The purpose of this chapter is to provide an overview of 3D Cadastre and explore general characteristics of 3D Cadastre and volumetric plans. This chapter also discusses the general characteristics of eSurvey and LandXML and explores the role of it for the development of 3D Cadastre. In addition to this, this chapter reviews the standards which are used in the Land Administration Domain Models (LADM). Finally, this chapter discusses the progress of digital lodgement of ePlan within different ICSM jurisdictions such as Victoria, New South Wales and New Zealand.

2.1 Introduction

Countries across the globe are moving from hard copy forms of cadastral plans towards the implementation of digital lodgement. Similarly, The Queensland Government has progressively moved to digital lodgement and electronic conveyancing. The Department of Natural Resources and Mines (DNRM) is the state authority responsible for managing spatial information and spatial data infrastructure. Queensland's eSurvey (previously EARL) is the digital framework which supports the digital lodgement of survey plan.

A literature review was undertaken to further develop the idea of digital lodgement into a research project. The purpose of this literature review was to gather relevant information about:

- the general characteristics of eSurvey;
- the performance of eSurvey and its implementation within Queensland;
- the digital lodgement progress of New South Wales, Victoria and New Zealand;
- the general characteristics of 3D Cadastre and Queensland 3D cadastral plans;
- Existing standards used by DNRM and other ICSM community for the implementation of digital lodgement for the development of 3D cadastre.

The eSurvey program allows the digital lodgement of survey plans and it has considerable challenges. eSurvey will capture, process, and update digital lodgement of survey data once it is operational. The primary purpose of survey plan lodgement is to support the Government's guarantee of title, and to facilitate subdivision activity, updating of land record systems and updating of the state digital Cadastral Base Map" (Falzon, Williamson 2001). The challenges for eSurvey are to go beyond its original functions of lodgement of survey plan and issue land title to the land owners

and fully support the digital lodgement and 3D data capture and updating. As the system moves away from hardcopy lodgement to digital, the guarantee of the land title and fully operation of 3D data capture and updating needs to be answered.

For many years the representation of spatial objects have been done satisfactorily using 2D, however 2D representation can be incomplete and limited (Billen,Zlatanova 2003). With new technology, spatial objects representations can be extended into 3D. The projection of a real world object in 3D space allows for a more true representation of the object as opposed to 2D space. The opportunity of working with 3D data allows surveyors to consider a world instead of a grid, which could have great benefits to surveying in urban environments.

2.2 General Characteristics of eSurvey

The DNRM has created a three stage process to facilitate the transition to digital lodgement. The first stage is the use of Surveying Information Processing (SIP) which is based on LandXML to capture survey information. The second stage is the implementation of electronic service where digital files can be lodged but the hardcopy process will still be used. The third stage is complete digital lodgement. eSurvey is a data package which provides an automation of survey plan validation check and visualisation. In addition to this, eSurvey will be able to create, validate and visualise digital cadastre data and streamline the processing and distribution of 3D cadastre survey data (ICSM, 2014):

When implemented, it is expected that lodgement through eSurvey will save time and money. The time taken to process survey plans currently depends on the time taken to:

- get the plans to the registration office;
- manually audit the plans;
- make correction if required;
- Lodge the plan in the system.

As illustrated in Figure 2.1, there are two main parties to eSurvey. The Surveyor who submits a plan and DNRM who validates and approves the plan.

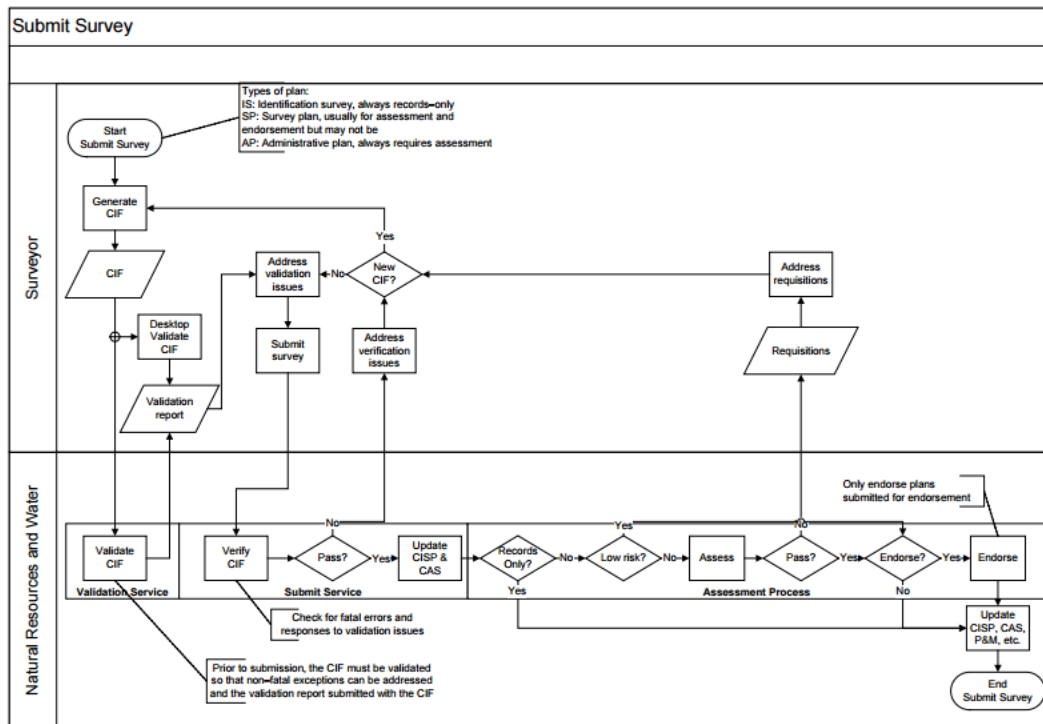

Figure 2.1 eSurvey submit plan process (State of Queensland, 2013b)

As validation of the electronically submitted plans are confirmed to have completed the necessary validation requirements. These validation rules can be divided into three parts (Karki et al, 2011):

- *Automatic validation checks of the file structure and completeness.* These rules assess the internal consistency of the plan, including dimensions and tolerances
- *Automatic validation checks of the content against existing data.* These rules verify that the new survey is compatible with information already in the Departmental databases and that the surveyor performing the survey is registered – i.e. No overlap between two ownership lots.
- *Manual validation checks for items that require subjective assessment and that cannot currently be completed satisfactorily by software.* For example, where natural boundaries are part of a parcel definition.

The first stage of eSurvey has already been successfully implemented with the introduction of the SIP and other tools. These in-built tools allow the processing and storing of data into the following databases:

- **DCDB** – (Digital Cadastral Database) the accuracy of DCDB varies widely from LGA (Local Government Area) to LGA.
- **SCDB** – (Survey Control Database) this data base holds all the permanent survey marks that serve as a control for Queensland.
- **SPDB** – (Survey Points Data Base) Fixed position of points which have been collected from the survey plan lodged. This can include everything from SCDB plus other points of interests including addressing, reference marks.
- **ATS** – Automated Titles Systems.
- **SDRN** – Survey Database Road Network
- **Place Names** – Names of streets, suburbs, and water bodies.

In stage 2 (Figure 2.2), eSurvey implements the electronic service delivery framework. This stage gives surveyors the option of a visualisation check and a preliminary data check. In addition to this, eSurvey II mitigates minor issues which could arise later in the submission process and allows auditing surveyors to analyse more complex tasks for lodgement. These tasks could be marked out by the surveyor who lodges the plan or be picked up in the eSurvey package (Karki et al, 2011). The eSurvey services portal allows users to submit, validate and visualise survey data via Web Services.

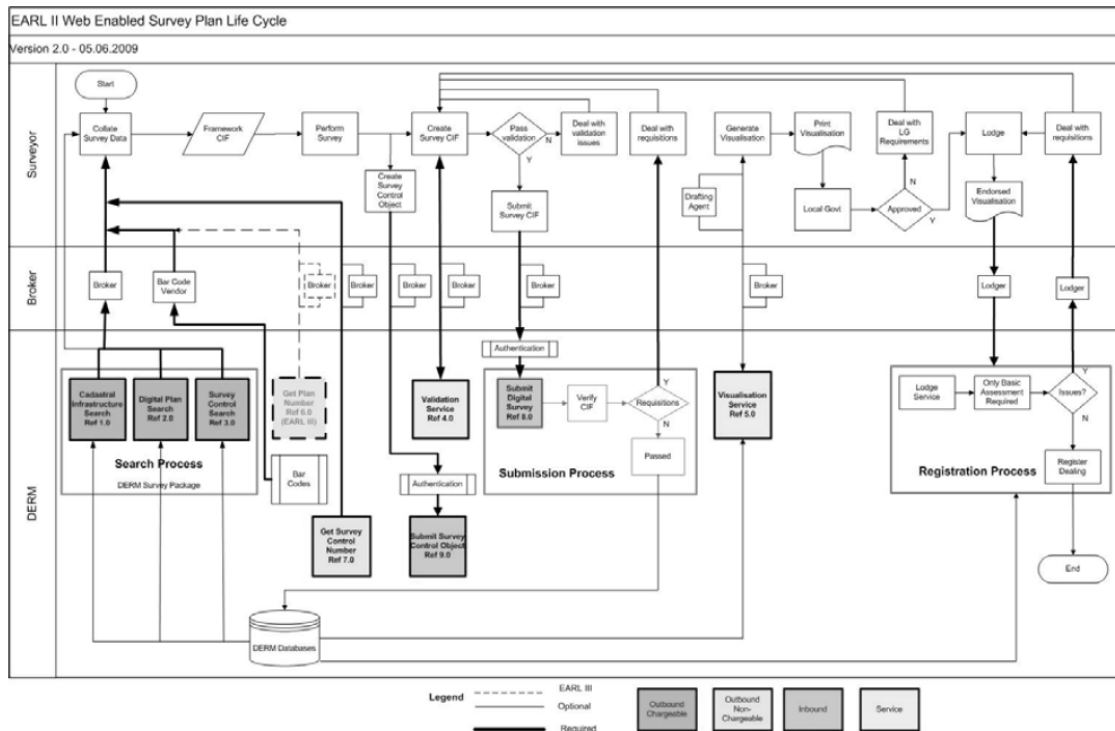

Figure 2.2 Phase 2 of eSurvey life Cycle (State of Queensland, 2014)

Current uses of survey plans are inefficient in the following ways (Shojaei et al. 2012):

- **Representing high rise buildings and developments:** due to the complexity of multi-level developments, numerous plans and sections that are required and difficult to interpret (Aien et al. 2011)
- **Storage and updating:** modifications are not easy and efficient with the existing paper and pdf file storage system
- **Queries and analysis:** searching and measurement can only be done manually.

Some of the reasons for the push for 3D cadastre and visualisation of the data are (Stoter, Oosterom 2006):

- **Technology push:** There is a rapidly increasing number of 3D visualisation systems in many disciplines providing realistic representation of the world with real-time navigation.
- **Public demand:** As people demand more access to information about their environment, they require effective means of communication that do not require specialised training.
- **Professional demand:** Nowadays, 3D visualisations are widely used in various applications such as architecture, urban planning, building development and disaster management. Professionals are looking at compatible visualisation systems to manage ownership of 3D information.

- **Resource efficacy:** Land and property, as important resources, requires modern management approaches for their sustainable use especially in populated urban areas.
- **Systems efficacy:** 3D visualisations increase the functionality of a cadastral plan.

The final stage will be the full use of the 3D cadastral plan including full digital lodgement of survey plans. Implementation of this stage is dependent upon legislation changes which will support the eSurvey validation rules. Additionally, there are technical hurdles remaining with the software which need to be rectified before its full implementation. Queensland Department of Natural Resources and Mines (DNRM) is working towards the implementation of eSurveyIII project now.

2.3 General Characteristics of 3D Cadastre and 3D Plans

The need for 3D Cadastre in Queensland for legal representation offers many possibilities to establish ownership of objects crossing several parcels. For example, easements can be registered for public utilities such as the supply of water, gas, electricity, telecommunication facilities, and be drawn on volumetric survey plans with their own geometry. The Queensland *Land Title Act 1994* allows the use of defining land into three different plans. The common cadastral plan is the standard plan that is mostly done as a 2D description of a cadastral parcel. The two other methods of defining land and representing survey plans are done in three dimensions (volume plan and building plan). This allows “any kind of mathematical surface can be represented as long as it could be defined by dimensions” (State of Queensland’s 2008).

However, there are significant challenges in incorporating 3D objects to which property rights can be attached as they are land parcels into existing databases (Karki et al, 2012). In the short term a practical solution for implementation of a full 3D cadastre could be to use the 2D parcels as a base for the partition of space (with their implied column volumes), and inclusion of volume parcels with a 3D description, e.g. in the form of a polyhedron. With this technique, there may be major technical and legal implications when implementing such a parcel based system (Stoter 2004). The Queensland Land Title Act 1994 provides two methods of defining land in three dimensions (3D).

2.3.1 Volumetric Plans

Volumetric format plans are defined geometrical parcels that are fully enclosed by facing surfaces and are defined by dimensions and levels which can be above or below the ground surface (Figure 2.3). The Queensland Land Title Act 1994 allows any mathematical surface as long as it can be defined by dimensions. Each lot is not dependent on any physical structure and indeed in practice the survey plan must contain plan, elevation and isometric views that make the shape and location of the parcels clear with the necessary bearings and distances annotated with it.

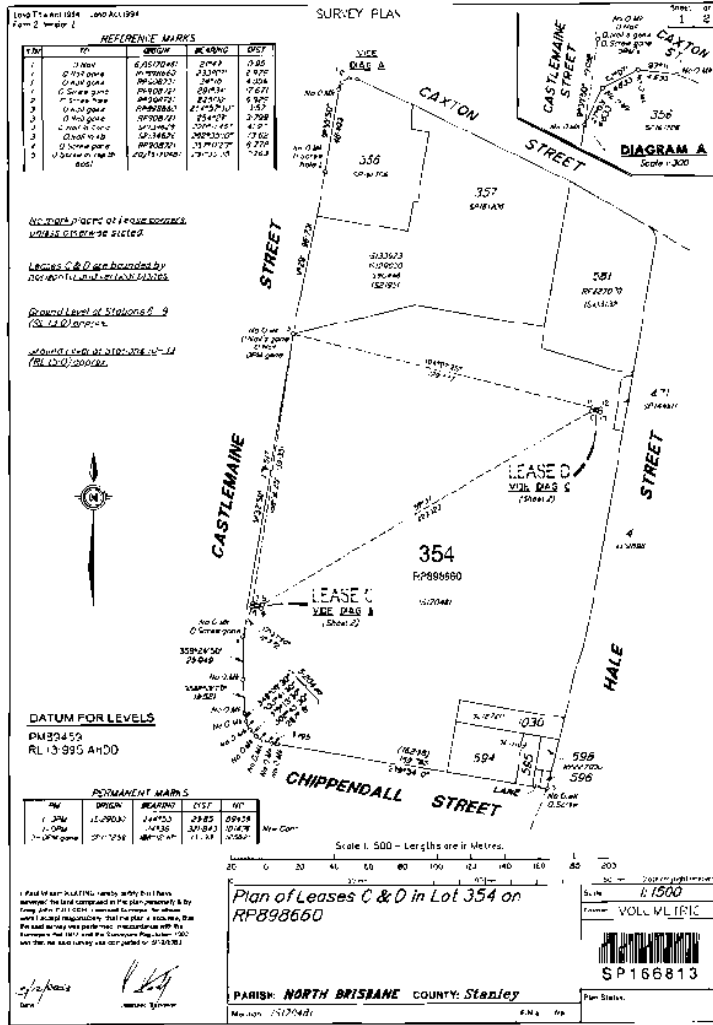

Figure 2.3 Example of volumetric format plan (SP166813)

Figure 2.3 Example of volumetric format plan (SP166813)

Figure 2.4 shows cadastral plans that have been created as a paper copy in an isometric view. Many complications can arise especially within more complex plans and during the 3D geometrical modelling of such volumetric plans.

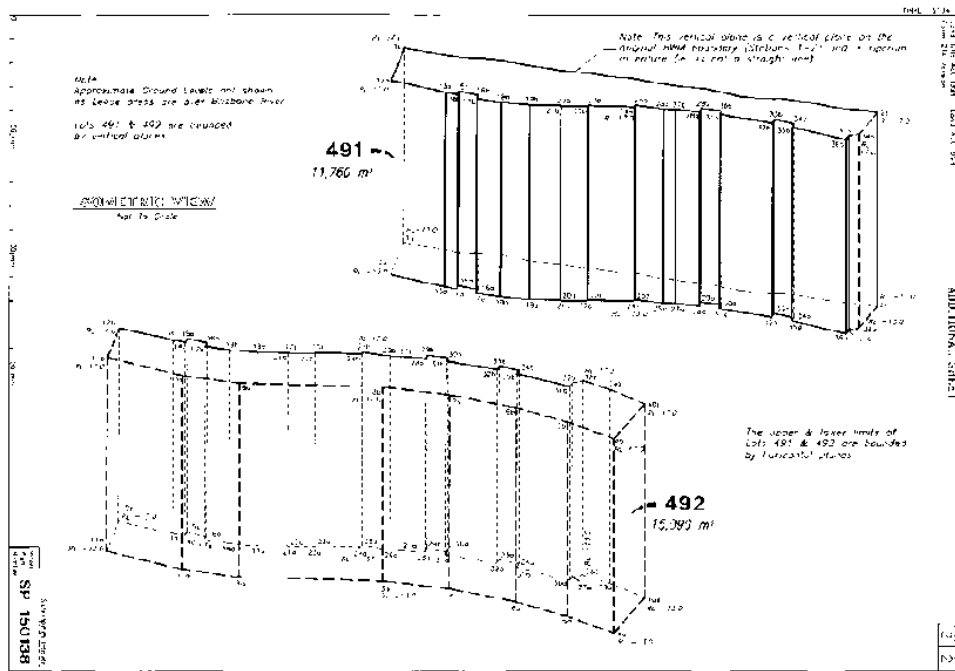

Figure 2.4 Example of a complex volumetric plan in isometric format (SP150138)

2.3.2 Building Plans

Each lot is defined by the use of physical elements such as walls, ceiling and floors. A building plan may consist of many different parcels in a ‘Strata Plan’ over different levels within a building. Currently these plans are stored and lodged in a 2D format which can become a complex representation of the parcel. The DCDB stores the boundary ‘footprint’ within 2D of the outline of the building. This is the most common form of 3D spatial representation worldwide and is often the only 3D supported form {Karki, 2012 #13}

Queensland’s legislation specifies that a 3D parcel can be treated in law as a conventional 2D parcel, and thus it may be traded, mortgaged or leased in equivalent transactions. Currently, however, the digital cadastral database (DCDB) can only store 2D footprints of 3D parcels and it is the only mechanism of building plans representation.

2.4 General Characteristics of LandXML

LandXML is an extensible mark-up language (XML) package which can be read by both humans and machines. It is a specialised XML data file which was released in early 2000 (Cromptvoets, 2006), and is used by surveying and civil engineers. LandXML was developed to enable data transfer, and long term data archiving. It is currently seen as a standard format of electronic submission in the industry, and this is the reason it was selected for eSurvey. Moreover, the Intergovernmental Committee of Surveying and Mapping (ICSM) has endorsed LandXML as the national standard for digital lodgement

of cadastral plans. In Queensland, surveying information is captured digitally using tools built in-house, such as the Surveying Information Processing (SIP) which is based on LandXML and is used to electronically capture a paper based cadastral plans. This decision to use LandXML for eSurvey was made through discussions with industry members.

The main suppliers in the spatial industry (Listech Australia, Topcon, and Trimble) have been working with LandXML and have also become partners. At present there is no cost to join LandXML which could be a major reason using LandXML by industry.

Some of the requirements for eSurvey (eSurvey) set out by DNRM are the following:

- Topologically valid;
- Efficient (e.g. capable of being stored in the database with minimal resource requirements);
- Facilitates querying, data manipulation and visualisation;
- Provides rich representation;
- Unambiguous data;
- Offers unique representation;
- Is accurate.

2.5 Industry Standards

One of the evaluation criterion for the quality of research project is the validation of findings. Validation is a familiar topic in computing, generally as a mechanism to catch errors and protect a database from the impacts of inappropriate data. As such, the validation rules are determined from the database schema using well understood standards. These validation standards will ensure that the incoming data is unambiguous and contains sufficient detail to define the legal and spatial extents of a property. All of the states within Australia follow the same land titling known as the Torrens Titling System. However, over time each state has slowly modified its system to reflect local society and law which creates a variety of semantics and data structures (Cummerford 2010). The Intergovernmental Committee on Surveying and Mapping (ICSM) has developed standards to support the future development of digital lodgement called ePlan. Queensland “will continue to support the development of eSurvey III but will need to rely on ISO/TC211 LADM 19152 to provide guidelines and requirements for the implementation of a homogenous and comprehensive land administrative model of Queensland” (Karki et al, 2011).

2.5.1 ISO19152

The Land Administration Domain Model (LADM) 19152 proposes a conceptual schema that organises the concepts and the relationships related to Rights, Restrictions and Responsibilities (RRR) and the

geometrical components associated with spatial representation of RRR. In using graphical representation such as that provided by LADM with the Unified Modelling Language (UML), we can more easily quantify and indicate specific classes, attributes and relationships that are either missing or are inconsistently applied between systems. The flexibility of the Standard Domain Model is in recognition that parties, spatial units and social tenure relationships may appear in many ways, depending on local tradition, culture, religion and behaviour{Lemmen, 2012 #20}. Recordation in ISO419152 may not only be based on formal registration of formal land rights, but may also be based on observations in reality, resulting in recordation of registrations. This is in support of participatory approaches resulting in data which can be managed by the people themselves. “A right may provide a formal or informal entitlement to own or do something. Restriction is a formal or informal obligation to refrain from doing something and responsibility is a formal or informal obligation to do something” (ISO19152/TC211, 2012). Exchange of data between formal and informal or traditional systems is possible now because of standardisations. The LADM allows a flexible approach in land administration at one side and supports national spatial data infrastructures (NSDI) for implementing land policies at the other side.

The LADM is used to outline the ideas of Van Oosterom and Lemmen (2006) (ISO/TC211, 2009). The LADM attempts to achieve standardisation in the area of cadastral data and provides common definitions for land information and facilitates the effective use, understanding, and automation of land related data, thereby enhancing data sharing. LADM has defined a class legal space (LA_LegalSpaceNetwork) for utility networks, associated with external classes for physical utility networks. This extended model gives a good idea of the relation between physical and legal representation of real objects. At this stage the differences between physical and legal objects (rights) do not necessarily coincide with physical objects (as is in underground utilities). Therefore, it is not the CIF file which is registered in LADM but only the legal space.

The implementation of ISO 19152 LADM based schema in the database helps to whether or not there is 3D representation in the database in any form and, if so how they are stored, represented, viewed and queried. The capabilities of 3D cadastral data are still being explored for data storage, data structure and validation strategies.

2.5.2 ePlan

Since 2003 the Intergovernmental Committee for Surveying and Mapping (ICSM) has sponsored a working party to develop a digital cadastral survey information transfer protocol to allow for consistent transfer of cadastral survey data between the surveying entities and jurisdictions. When the protocols are compared, the ICSM “ePlan model has significant overlap with the LADM (ISO-

DIS/19152) (iso-tc211, 2012) which is a draft international standard for cadastral information” (Karki et al, 2012).

The ICSM ePlan Protocol in November 2009 was released to the survey software vendors so that they could develop the tools required by the surveying industry to take advantage of the increased efficiencies offered by the digital submission of survey data.

The ePlan working group was formed at the meeting and subsequently ratified by the ICSM. All jurisdictions expressed an interest in moving digital lodgement of cadastral survey data/plans. It was finally decided that the working group could only look at the transfer protocol, with individual internal implementations being the responsibility of jurisdictions, since each jurisdiction has its own well defined set of business practices and operational system. There are several objects which the ePlan protocol set out, such as the model (representation of the object), standard, protocol (implementation of ePlan, constraints in LandXML, use of LandXML), and jurisdictional schemas (legislation, administration boundaries, parcel class).

The working group had the following main terms of reference to produce a generic UML model for cadastral lodgement{Intergovernmental Committee on Surveying and Mapping, 2010 #15}.

- The model must have the ability to harmonise with existing ICSM eConveyancing models as well as the New Zealand eSurvey and eDealing models;
- The model must handle both the spatial and legal functions of the plan;
- The model must facilitate the update of cadastral mapping systems, survey indexes and searching tools, as well as survey control data sets and street address data sets, and allow for generic jurisdiction specific elements to be added;
- Develop or identify standard tools based on the generic UML schema that would facilitate data capture, visualisation and validation functions with the ability for the adaptation of specific jurisdiction requirements;
- Develop a high-level business case for the adoption of an ePlan standard;

The standard used to support this model, could be any internationally adopted standard for the transfer of data. After investigation, LandXML was selected mainly because of the use of LandXML by New Zealand in its digital lodgement, but also from feedback within Australia {Intergovernmental Committee on Surveying and Mapping, 2010 #14}.

Currently the ability to define geometric objects such as points, lines, curves, irregular lines, polygons and volume are defined. The following structure is used in the ePlan for storing the geometry objects:

- CgPoints (includes attributes and position which can be 2D or 3D);
- Parcels (includes attributes, CoordGeom (boundary of parcels defined by lines, irregular lines and curves) and VolumeGeom (volumetric parcels defined by LA_BoundaryFace);
- Surfaces (digital terrain models);
- Plane features (generic geometric data such as occupation in the form of structures).

From the following methods ePlan has recommended volume representation and boundary representation to define volumetric objects (VolumeGeom).

2.5 Other Digital Lodgement within ICSM Community

Digital lodgement offers significant benefits in terms of process improvement and new business opportunities for surveyors. With digital lodgement, surveyors will benefit efficiency of the development process; from inception to registration.

Due to the increasing need and opportunities associated with digital lodgement, many states alongside Queensland have invested into the ability for digital lodgement. Such developments from projects are ePlan from New South Wales, SPEAR from Victoria and Landonline from New Zealand. All of these jurisdictions/projects are members of the ICSM and have also used ISO19152 for geospatial standards. The following section discusses the digital lodgement arrangements within ICSM community.

2.5.1 New South Wales (ePlan)

New South Wales has several projects running for implementation ePlan. The most significant being the development of a lodgement portal for the receipt of digital plans (Cumerford, 2010). The ePlan digital lodgement for New South Wales has adopted the use of LandXML and web portal SIX (<https://six.nsw.gov.au/wps/portal/t>). As of current, the service is in the prototype stage, however, it has a later expectation of automatically validation and rendering of LandXML data, as well as LandXML plan files that are compliant with the National ICSM standards and NSW specifications (NSW Government, 2014).

ePlan is utilising the ESRI (ArcGIS Platform) suite of products and is developing an interface between the CIF and the ESRI Cadastral Editor product for digital processing and plan auditing. It has codified its business rules and published its jurisdictional schemas (Cumerford, 2010).

2.5.2 Victoria (SPEAR)

Surveying and Planning through Electronic Applications and Referrals (SPEAR) is the Victorian Government initiative and Victorian digital lodgement project which has also been developed with the national data model ePlan. SPEAR uses Cadastral Information File (CIF), which is a LandXML file that contains information in a subdivision plan based on the ePlan schema (SHOJAEI et al, 2012). Melbourne has also turned to 3D technologies to support the production and management of complex building information and this has also been extended to the land administration sector. This can be due to the cultural shift towards high rise living which has outstripped growth in freestanding dwellings (AIEN et al, 2011b). The current legal ownership rights of 3D objects are representations in 2D, (SHOJAEI et al, 2012), which is not efficient for multi-level and complex scenarios. The web based Land & Survey Spatial Information (LASSI) is being used for internal updating, editing, analysis, and visualisation of the data.

2.5.3 New Zealand (Landonline)

Land Information New Zealand (LINZ) is the national mapping organisation and Landonline is the national initiative run by LINZ and is the first operational online service in the Australia/New Zealand Region which allows surveyors to complete digital lodgement with the use of LandXML (GRANT et al, 2014). As New Zealand is a member of the ICSM, it is developing a national strategy for Cadastral Reform and innovation for Australia which are both aimed to be implemented (GRANT et al, 2014). Although Australia and New Zealand have different complexities in federal jurisdictions, legislation and governance of their cadastral systems, they share the same vision statement in cadastral domain as, “A cadastral system that enables people to readily and confidently identify the location and extent of all rights, restrictions, and responsibilities related to land and real property” (GRANT et al, 2014). The following goals have been outlined to support the success of landonline project:

- The public confidence is maintained as the cadastral system is developed;
- The cadastre includes the extents of all rights, restrictions and responsibilities;
- Complete spatial representation of rights, restrictions and responsibilities;
- The quality of the boundaries of rights, restrictions and responsibilities matches the need;
- The cadastral system efficiently receives information from sources with appropriate levels of trust;
- People have access to cadastral data which is able to be integrated with other data sets.

LINZ cadastral information will be available in real time which and will be maintained with new advances in technology and social demands. The use of ISO19152 will be incorporated for geospatial standards to develop principles and standards.

Some of the objectives of New Zealand Cadastre 2034 are to (GRANT et al, 2014):

- Survey accuracy for spatial datasets to facilitate layering of different spatial datasets;
- Object oriented towards property objects rather than parcels;
- 3D/4D to align with other 3D and time variant datasets;
- Provide real time support for users to continuous access and updates;
- Align with international standards and best practice;
- Create an organic model for 3R's based on the natural environment.

2.6 Conclusions

The current abilities of 3D cadastre have been reported in this literature review. This includes a current understanding of the capabilities of 3D cadastre. Some of the possible solutions in which 3D cadastre can be employed such as 3D tags in the current cadastral registration (Stoter, Salzman 2003). The issues which need to be overcome such as representation, validation and 3D representation were detailed, along with as the implantation of eSurvey and the three stages of the project. The use of LandXML to become a standard format within the industry and other digital lodgement with in the ISCM community were discussed.

Chapter Three

3 Methodology

The previous chapters of this dissertation discussed the characteristics of 3D cadastre, 3D survey plans, LandXML and the current digital lodgement practices in Australia. This chapter discusses the project methodology and research design framework.

3.1 Project Methodology

The objectives outlined in Section 1.5 forms the steps for obtaining results in this project. Each objective has been addressed in the project conclusion.

3.2 Project Intellectual Property

The software packages, data and web portals used in this project are:

CivilCAD

Version 7.00 of CivilCAD was used and made available by the University of Southern Queensland.

AutoCAD

There is currently an AutoCAD add on (LandXML4C) which is available on the NSW Government web portal. The use of AutoDESK CivilCAD 3D (version 2016) was used for the export of data from AutoCAD (version 2016).

Trimble Business Centre

Version 3.5 of Trimble Business Centre has been used. It was also made available by the University of Southern Queensland.

eSurvey

eSurvey, as described in Chapter Two is “an electronic plan lodgement and validation system developed primarily by LPI that is a faster more secure and more efficient way of processing land title plans” (State of Queensland, 2015a). Queensland Government has also developed eSurvey portal (previously known as Electronic Access for Registry Lodgement-EARL Services) which allows to exchange survey and survey control information electronically. The use of eSurvey portal (<https://survey-portal.information.qld.gov.au>) for the validation, rendering, and visualisation of survey plan was done between 26/09/2015 and 05/10/2015.

3.3 The Study Area

The two representative cases were selected from Queensland digital cadastral database (DCDB). As illustrated in 3.1, two big metropolitan sites, Brisbane and Gold Coast were selected where there are issues with registering high rise buildings and implementation of 3D cadastre. Two typical cases of volumetric plans were selected, one is volumetric encroachment and the other is volumetric doughnut. SP21499 is in the suburb of Woolloongabba on Stanley street and SP166505 is in the Gold Coast.



Figure 3.1 Location map of case study areas

3.3.1 Survey Plan I (213499)

The first case study selected for this dissertation was a volumetric plan of a volumetric encroachment. The volumetric plan is of an outdoor area for a private business in the inner city of Brisbane (Figure 3.2). This volumetric encroachment at Woolloongabba is located between Stanley Street and Hubert Street. This presents an example of the creation of a volumetric parcel infringes in strata in the 2D space of road parcel. This plan is mentioned to be “Road to be closed in Strata title”. The volumetric plan allows the owner to utilise an area to which they have access. However, creation of this does put in place restrictions of rights of the road. In addition to this, there are simple shapes and lines in the plan and this was another reason for the selection of this plan as case study. The area of interest, while in 2D plan view, can be seen as an encroachment. In this case, the owner has used a pre-standing structure to create an outdoor entertainment area. The area is built over the footpath which will not affect the current use. The volumetric plan allows both the owner and the Crown to make maximum use of the land.

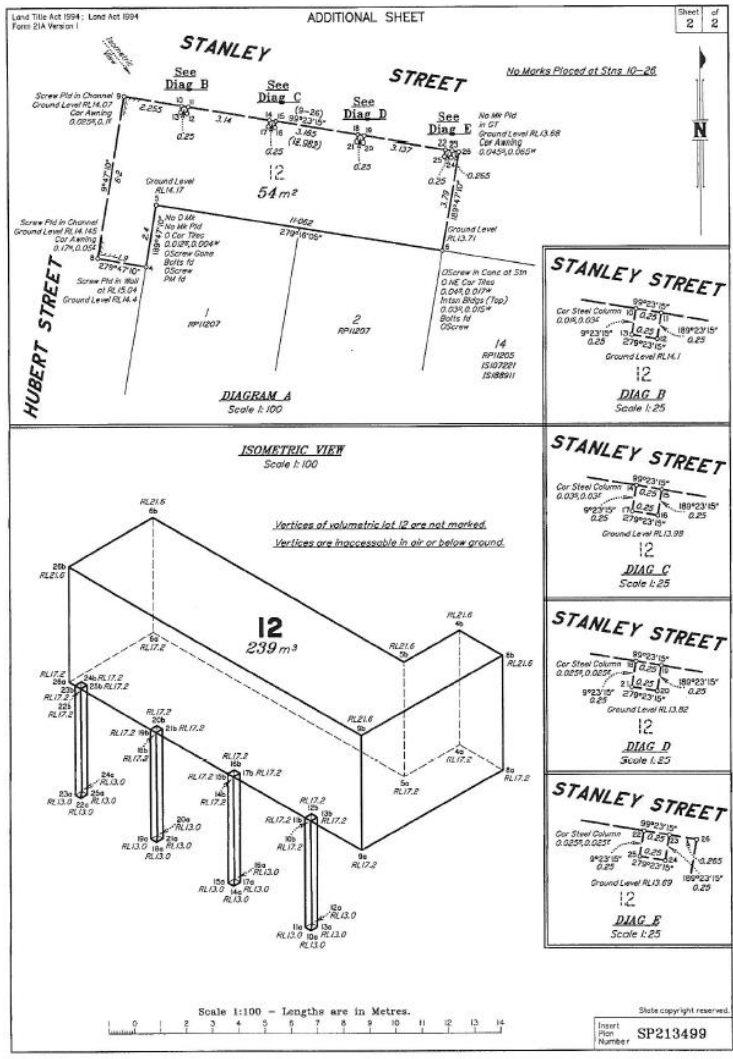

Figure 3.2 Case Study One Volumetric Plan (SP213499)

3.3.2 Survey Plan II (116505)

The second case study was a Volumetric Doughnut which is located in Gold Coast Queensland (Figure 3.3). The definition of complex curves and the overlaying nature of the 3D airspace create issues within LandXML. The shaft which runs down the centre of the parcel will need to be defined as a cylinder which changes in diameter as the elevation changes such as a conical. Furthermore, three of the Doughnut’s volumetric Lots overlay each other in the horizontal position. The current DCDB stores this Doughnut as a separate foot prints instead of one. By registering each parcel separately allows the overlapping of each Doughnut Lot. The registration of the Doughnut Volumetric Lots are necessary due to rights which are reserved to the airspace for communication equipment.

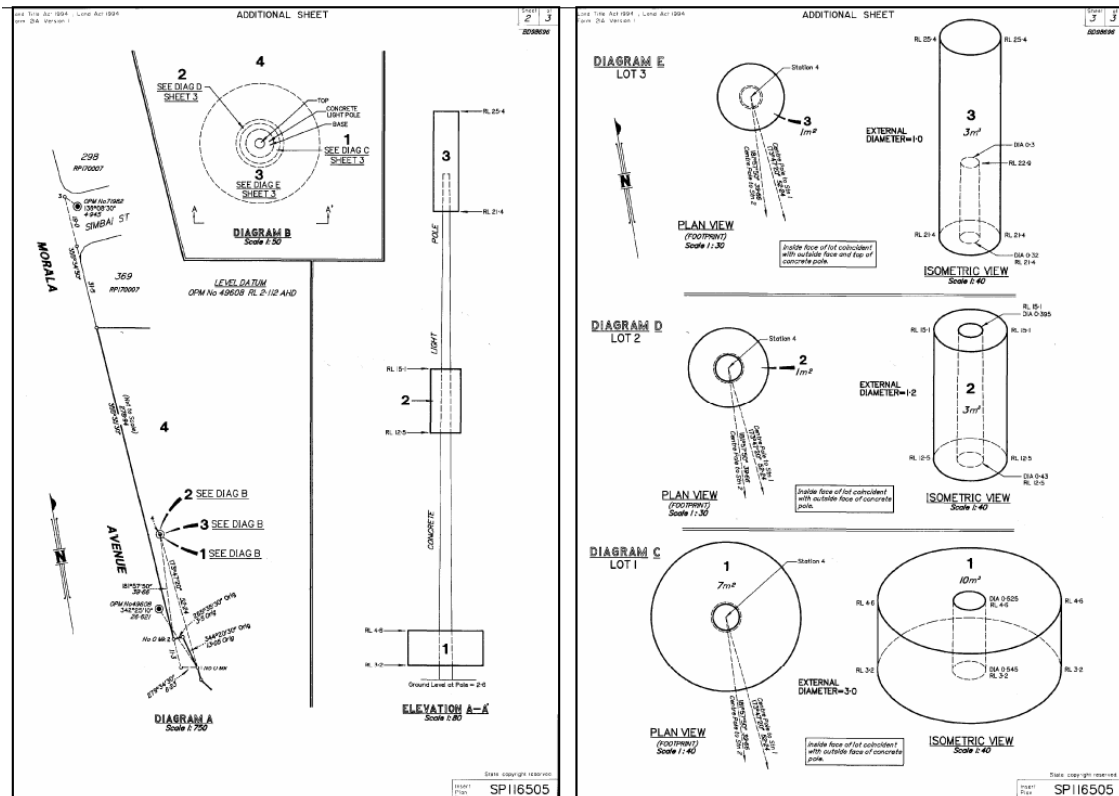

Figure 3.3 Case Study Two of Volumetric doughnut (SP116505)

3.4 Validation of 3D Cadastral Data

One of the evaluation criteria for the quality of project findings is the validity of findings. Data validation is also important during the upload processes. Knowledge pertaining to this case study area has been referenced from ISO19152/ePlan/Queensland interchange format specifications (QIF). DNRM has developed the CIF specifications to ensure that the required standards are met and the accuracy is achieved. The boundaries mark the discontinuity in the relationships (rights) between people and land (or space). Represented within a 3D volume primitive, the rights are homogenous. Each of these three dimensional (3D) entities have both physical and legal descriptions. The latter describes ownership rights, restrictions and responsibilities (RRR's) of physical objects. An efficient 3D visualisation system requires a representation of the physical objects and a visualisation of their legal counterparts. This is to ensure that the incoming data (in case a plan of cadastral survey) is clear and contains sufficient detail to define the legal and spatial extents of a property (Karki et al, 2013).

Each of the case studies has had different requirements and RRR's for the definition of a legal object. Through the package diagram below (Figure 3.4, Figure 3.5), the harmonised data model has been represented in LandXML.

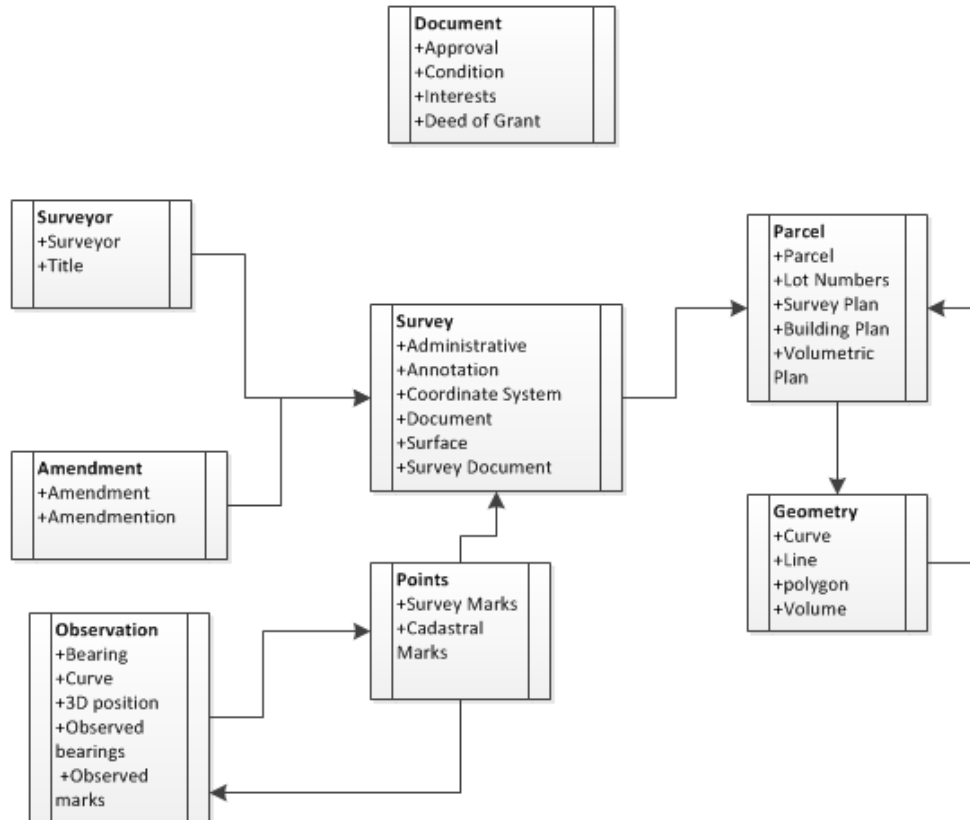

Figure 3.4 Harmonised data model showing the package diagram within LandXML.

The Harmonised data model (Figure 3.4) shows some of the requirements needed for the digital lodgement in Queensland. These sections support the administration and creation of the parcel to ensure the accuracy of the DCDB.

The purpose of the harmonised data model is to represent the data to the required RRR's. The ePlan model packages (ePlan 2010) show the RRR which can be attached to the LandXML data. Figure 3.5 shows a version of the ePlan which has been changed to accommodate some of requirements of DNRM for eSurvey.

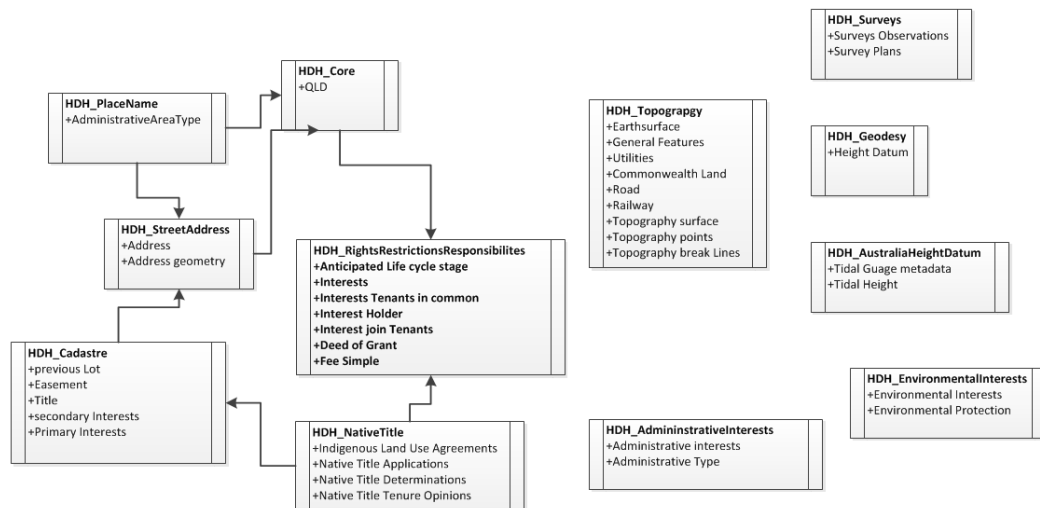

Figure 3.5 ePlan Model Packages (ePlan 2010) showing the RRR's within LandXML data

With the use of the harmonised data model, a validation list has been created. This list refers to the LandXML schema (LandXML.org) which has been developed for the validation of the LandXML for this report.

The eSurvey web portal validation tool (Figure 3.6)(Australian Government Information Management Office, 2006; State of Queensland, 2014) has been used to validate the CIF with the LandXML data to in the first phase. It is common practice that incoming data should be compatible with the database design assumptions (Karki et al, 2010). Validation is required before importing of data into the DCDB (Karki et al, 2010). Validation is also necessary for correct manipulation of DCDB (Oosterom et al, 2013). However the 3D Cadastre is “more complex as it gives rise to the primary problem of unambiguously defining the 3D parcel and its extent” (Karki et al, 2010). As eSurvey will at some point more from DCDB into a 3DCDB, one such method is the possibility of having a hybrid DCDB. This was discussed in the literature review. The hybrid technique was suggested by the LADM (Rodney James THOMPSON, 2012).



Figure 3.6 eSurvey services web portal

Figure 3.6 shows the DNRM eSurevy home page. There are two types of services offered by eSurvey. Validate CIF, visualise CIF and order survey controls (Image and report) are free services. Likewise, order digital survey plan and order cadastral search are the charged services. Both internal and external validations can be performed through this web portal. The internal validation of the CIF is conducted first. This gives the internal validation compared to the external validation which compares the internal CIF to external information. If any of the internal validation triggers a fatal error, the processing of the CIF will not be completed until the error will be resolved. The Internal validation rules can be divided into two parts:

- **File formatting and conformance checks:** such as all mandatory fields are present; all values that must be selected from lists have appropriate enumeration values, and so on
- **Internal data consistency checks:** such as any created parcel closures are within tolerance (State of Queensland, 2013a).

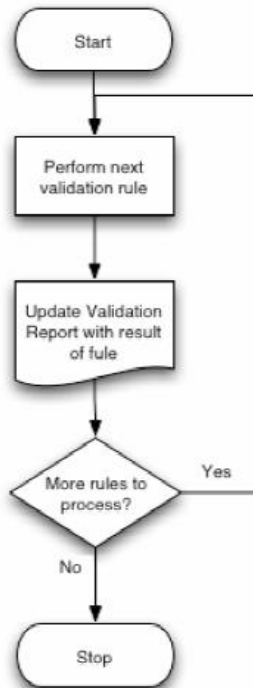

Figure 3.7 Validation rule process flow (State of Queensland, 2013a)

An external validation of the CIF can be completed against the current data relating to the CIF (Figure 3.7). Some of the external validation checks include title referencing, adjoining Lots checks and secondary interests checks (State of Queensland, 2013a). If any of these validation rules will not be satisfied, a fatal error will be activated. The fatal error of the CIF will not allow submission of the file until the errors will be corrected. The eSurvey CIF validation rules underline that under no circumstances fatal error occurs.

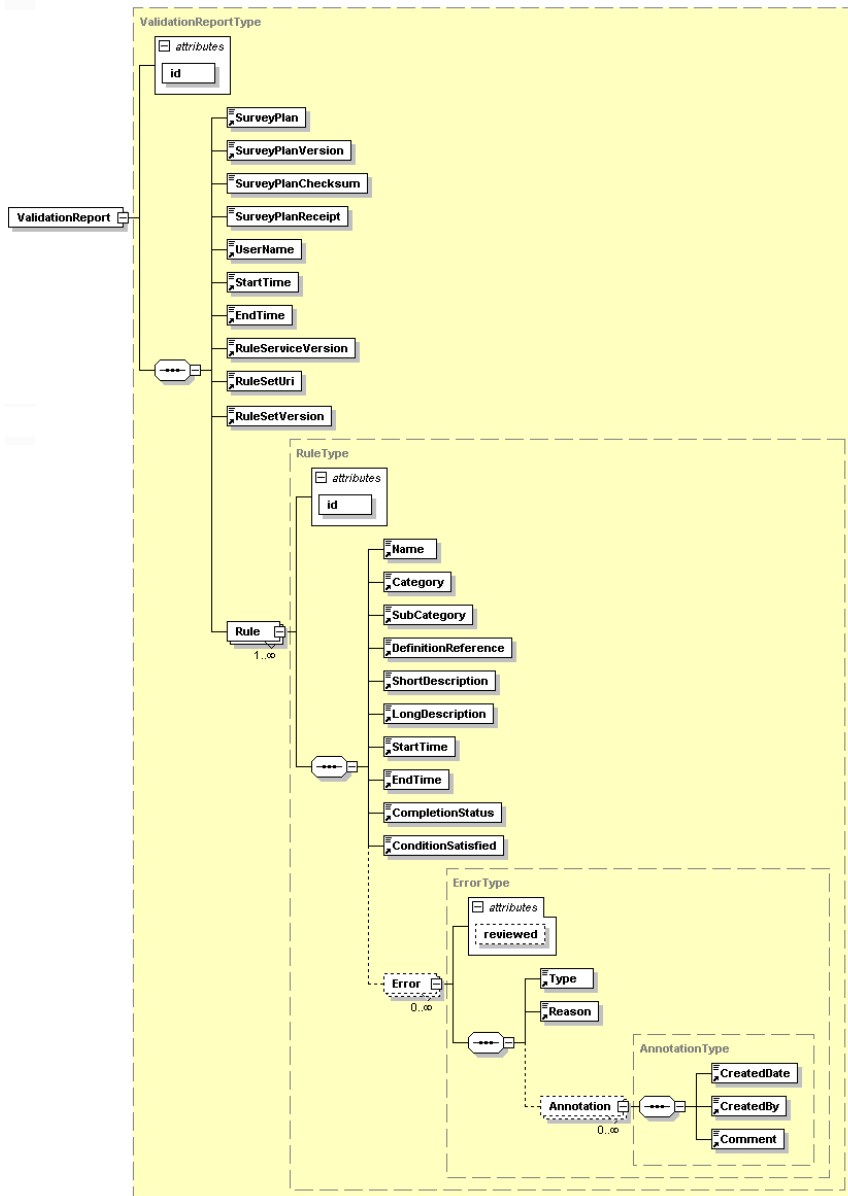

Figure 3.8 Validation report layout of eSurvey CIF validation rules

A description of the elements which will be under review in the second phase has been presented in Appendix B. Table 1.3 illustrates the attributes and expected outcomes during validation process.

	Expected
Line	Most CAD packages should have the ability in 2D to create and store. Possible issues with 3D as starting and ending of line is in 2D.
Survey Header	Only the AutoCAD LandXML4AC has an inbuilt system which will export a survey header. It is expected that the survey header can comply with ISO19152/ePlan standards. Due to

	the other CAD packages not producing the required LandXML survey header, there can be a need to complete appropriate editing to the LandXML file for the eSurvey rendering system to work.
Surface	The surface element is expected to be produced by the CAD packages. LandXML can be used to define a surface with a collection of points and lines in engineering jobs.
CoordGeom	It is expected that a CoordGeom as a footprint of plan can be created. However, when elevation values are added, the likelihood will decrease with the current capabilities.
PntList2D	As eSurvey is in the second stage there is an expectation that PntList2D function will work.
PntList3D	Currently eSurvey is its early second stage. There is a possibility that some CAD packages may be able to create a PntList3D. This is due to CAD software ability to create points with elevation values.
CgPoint/ CgPoints	The likelihood of both eSurvey and CAD packages understanding the function of CgPoint is most likely. Once an elevation value will be attached to the CgPoint the likelihood of eSurvey able to render the script.
Parcel	AutoCAD with the LandXMLA4C should be able to comply with ISO19152/ePlan standards. The other CAD software will attempt and replicate the standards. This attempt can be achieved with layers and required descriptions.
Curve	Most CAD packages should have the ability in 2D to create and store the required information in the exported LandXML file. It is expected that eSurvey will have the necessary abilities.

Table 1.3 List of elements for the Validation

The expectation column describe the expected values (Figure 3.9). This could be one of three options:

- **Error** – Error mean the possible error when the data does not come. This error can be seen in CAD software or during export stage. This error cannot be linked back to the software’s ability because it is possible that the input data used for export is invalid. It can also be suspected that the original function of exporting LandXML has not been met.
- **Complete** – expectation that the creation of the type is complete and will be represented as a schema.
- **Not Completed** – no attempt at creating the type was completed.

Possible outcomes of exported LandXML files:

- **None** – no outcome can be expected. This is due to the error which was acknowledged by CAD software.
- **Exported** – the element was described within the LandXML data by theSchema which the software uses.
- **Not Exported** – no error was displayed by the software (of the export data) which cannot be reported during data output. This cannot be linked back to the ability of the software function as no error was advised. Figure 3.9 illustrates the workflow of possible outcomes of LandXML files.

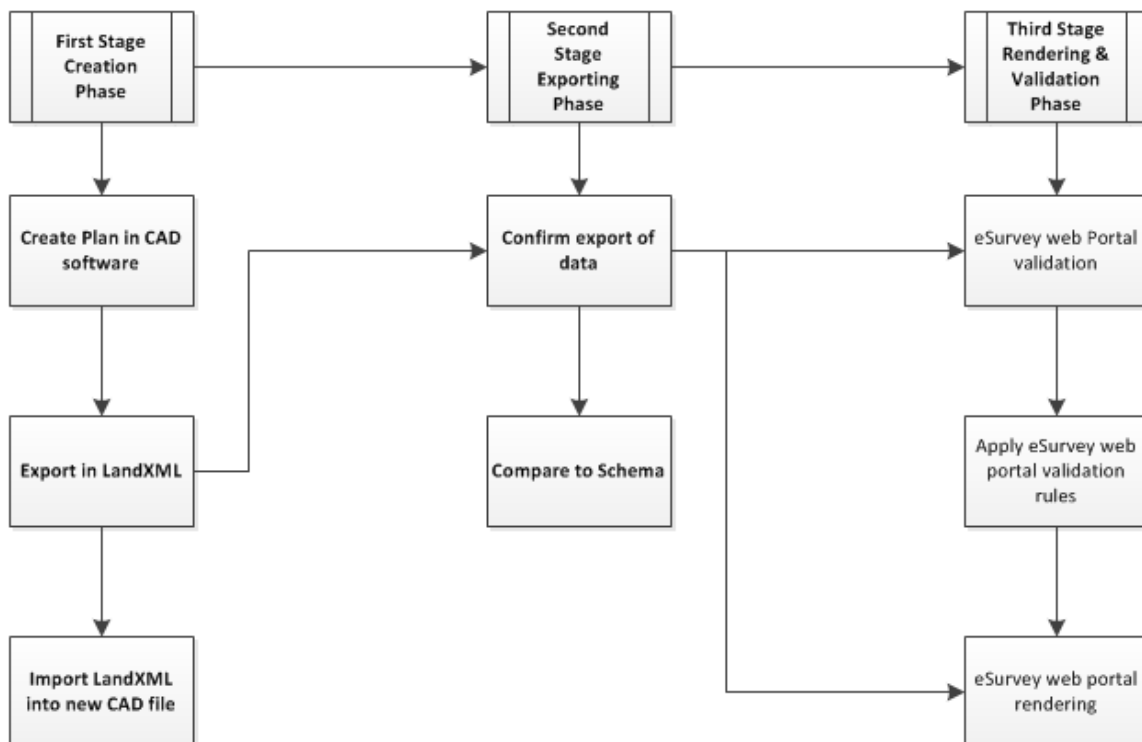

Figure 3.9 Showing possible outcomes of expected LandXML files

3.5 Research Design Framework

This section describes the research design framework which examines the research methods that are suitable for addressing research questions to achieve research objectives. The research framework shows the stages of methodology has been attempted to represent the whole process of a digital cadastral plan lodgement (Figure 3.10). There are mainly three phases, creation phase, exporting phase and the rendering and validation phase.

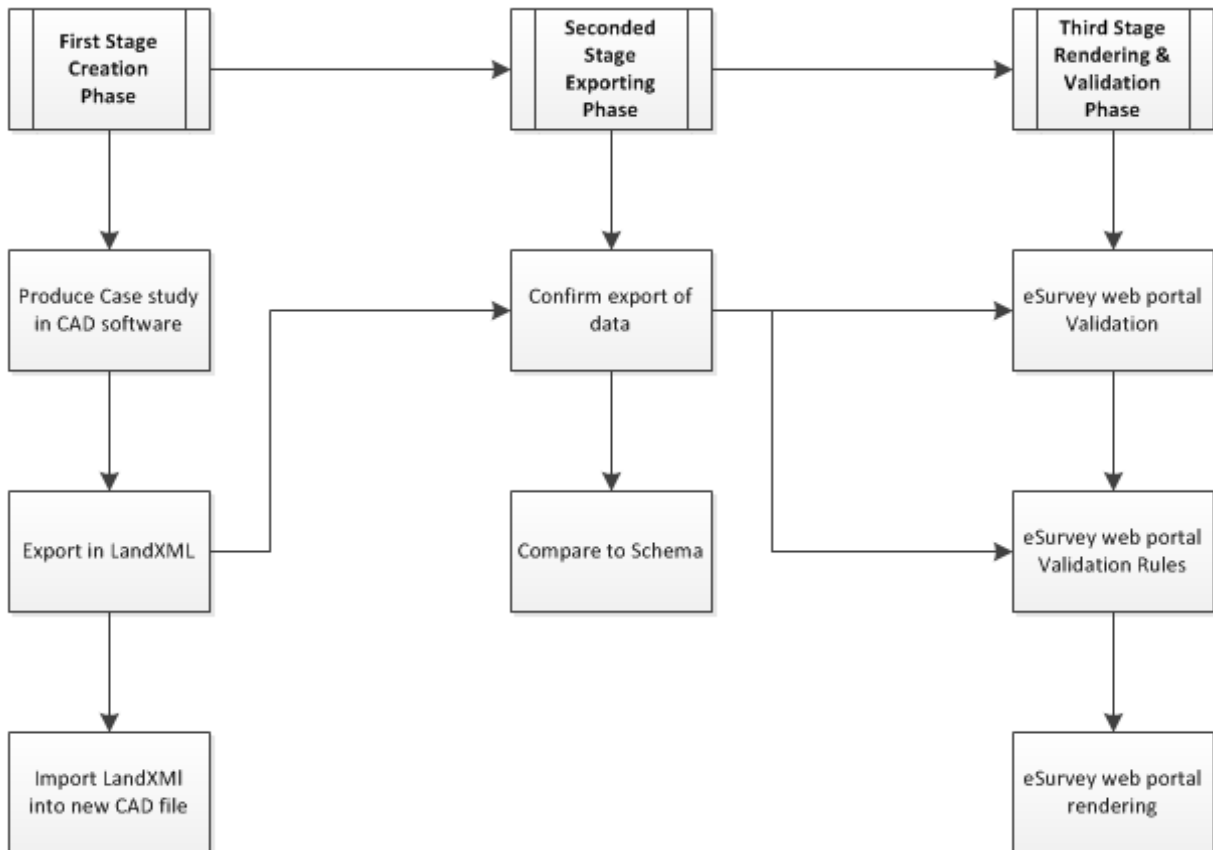

Figure 3.10 Stages of the methodology

3.5.1 Creation Phase

The creation phase is a replication of the survey plan using selected CAD packages. The drafting of the case studies (survey plan) will be created in 2D format and 3D format and capabilities to represent the lots will be checked. Elevation data of the plan will also be included to the points and lines data.

3.5.2 Exporting into LandXML File

The Exporting Phase analyses the current ability of the CAD packages to export into LandXML files. The LandXML file is exported from CAD software putting elevation values. Different layers are created so that the data allows the required functions which have been set out in ISO19152/ePlane

standards. The attributes of the data is analysed during import. Some of the queries and functions are to:

- Find adjacent objects of a 3D legal object, both vertically and horizontally to identify affected RRRs;
- Merge and subdivide volumes to facilitate the registration processes;
- Trace utility networks and infrastructures (e.g. tunnel and bridges) and control the proximity with ownership boundaries and detect collisions;
- Control the spatial validity (e.g. volume is closed, no overlap between neighbouring volumes, no unwanted 3D gaps).

This has allowed the DCDB to store and provide a representation of 2D legal objects but 3DCDB has also allowed the provision of 3D spatial objects. The bounded 3D cadastral of these developments require numerous plans and sections which are difficult to interpret. The technical perspective on the proposed solutions comprises the discussion on how to implement 3D objects in the current cadastral geo-DBMS in which the 2D Lots are stored (van Oosterom, Lemmen 2001). The integrated architecture which the geometric, as well as the administrative data of objects, are stored and maintained in one geo-DBMS should be the starting point for a 3D cadastre (Stoter, van Oosterom 2002). Currently the capabilities and functionalities of 3D objects are not being used.

All of the selected CAD software has an ability within the program to allow the export of LandXML. This ability has been used although it will not give an accurate insight into the ability of eSurvey to process CAD file and convert it into to CIF and LandXML. This process has given an insight to the current CAD programs and how they are able to define the require data into LandXML to hold 3D data. Once the plan has been created and saved, the data will then be exported using the export function.

3.5.3 Rendering and validation Phase of LandXML File

The third stage is the rendering and validation phase. The rendering and validation phase will check the ability of the eSurvey (Figure 3.6) to upload LandXML file. This phase will also examine the capability of LandXML to hold the script which is required by current standards.

3.6 Conclusion

This chapter presented the research methodology to achieve research objectives and aim. Three CAD packages CivilCAD, AutoCAD and Trimble business Centre are suggested and eSurvey web portal has been used to create and analyse the data. Two volumetric survey plans has been suggested to

test the data. The research design framework has three stages the creation phase, the exporting phase and the rendering and validation phase.

Chapter Four

4 Results

The previous chapter discusses about the literature review and research methodology. This chapter discusses the results which have been obtained based on the methodology. The summary of findings has been documented into three stages as creation phase, exporting phase and rendering and validation phase.

Three CAD software packages have been used to create survey plans and convert them into LandXML files. The next section discusses the rendering and validation of uploaded LandXML files into eSurvey Web portal. Finally, the comments have been made on the ability of the CAD program to represent 3D data and validation of these data through eSurvey portal.

4.1 Summary of Findings

This section breaks down the results into the stages.

Creation Phase -The creation phase is the creation of survey plans using CAD packages and replication of survey data / plan that was logged in Queensland.

Exporting Phase - The exporting phase is the exporting of the CAD data into LandXML file.

Rendering and Validation Phase – This is the import of LandXML data into the eSurvey web portal for rendering and validation for 3D digital cadastral database (3DCDB).

4.2 Creation Phase

This section discusses the results and the internal validation of the case study survey plans in 2D and 3D format. The plan was replicated using CAD program entering dimensions that were lodged with the survey plans.

4.2.1 Survey Plan I (SP213499)

This Section has looked into the creation of the SP213499 survey plan using three CAD software packages Civil CAD, Trimble Business Centre, and AutoCAD. Comments have been made on the ability of these three software programs to present survey plans into 3D cadastre.

4.2.1.1 CivilCAD

The hard copy plan of SP213499 was selected and data were entered to create survey plan. The points and lines were created. Layers were set at default values to allow the transfer of the attributes of line information. This was a simple process that contained little error.

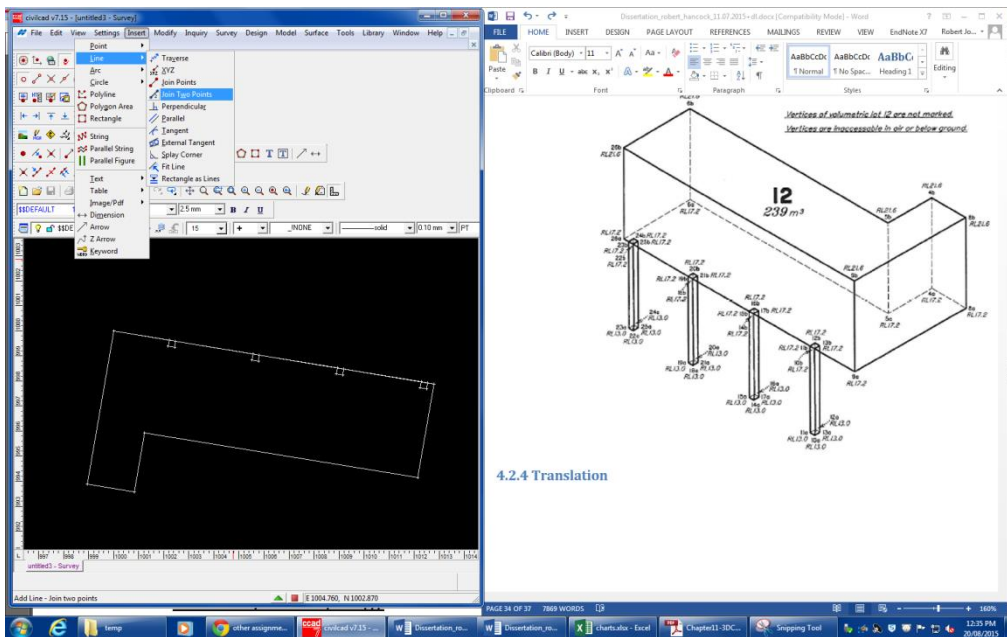

Figure 4.1 CivilCAD in 2D view

When creating a vertical line, there was no change in horizontal position. However an error did occur using CivilCAD software. In particular, the creation of a line inserting starting and ending points did not change its horizontal position. This caused some confusion within the CivilCAD software (Figure 4.1).

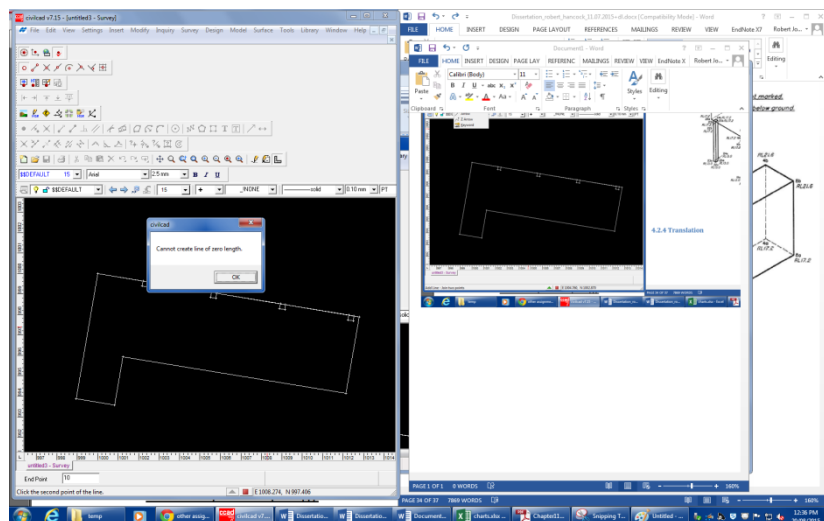

Figure 4.2 CivilCAD and the creation of a line with of zero length

In Figure 4.3, the left hand side shows an attempt to create a parcel. Only the left back vertical line was created in the parcel. Additionally, two lots were created in a new CivilCAD file (Figure 4.2), which ran parallel to each other at different elevations. Due to the lack of creation of vertical parcels the lots were not able to cover the object creating a full boundary. This full close around the object

as a full boundary has been described as being 'watertight'. This was happened due to the reason that it was not being able to create an object. This was not 'watertight' as it is only a representation of the Lot/parcel in 3D. Within 3D Cadastre, the Lot must be as a true object should be intended to give a legal representation of the object.

A second attempt was made with CivilCAD. Points were created with three CoordGeom (Figure 4.3). The first and second created CoordGeom could be seen in the 3D viewer. The third CoordGeom could not be seen. Only three of the four lines were seen in the display, with the second line which ran completely not displaying the vertical. The CAD file was exported using the export function.

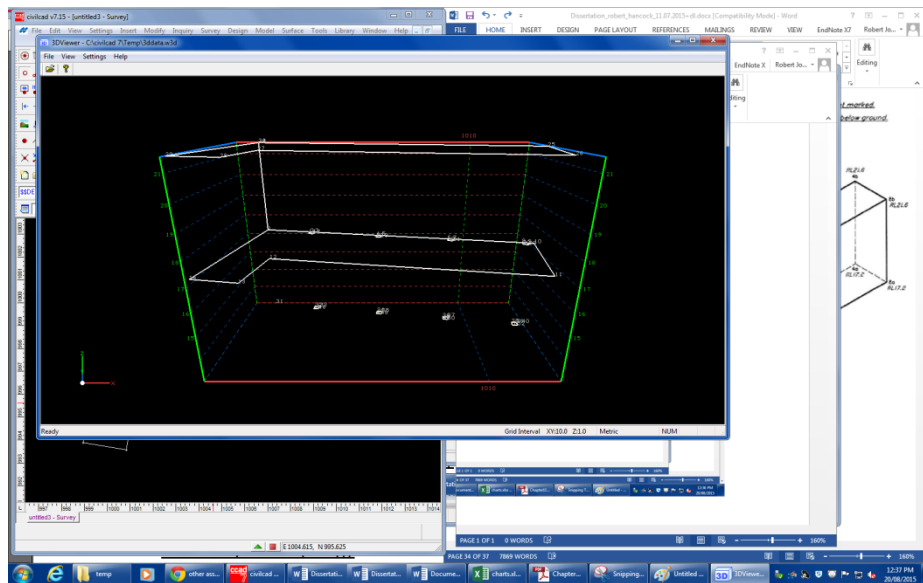

Figure 4.3 View of a parcel in 3D

The LandXML file was imported using the in-built function in CivilCAD. The sample which was created with lines as illustrated in Figure 4.3, held the lines which represented the top of the CoordGeom. However, the representation of the bottom CoordGeom did not follow the intended creation (Figure 4.4).

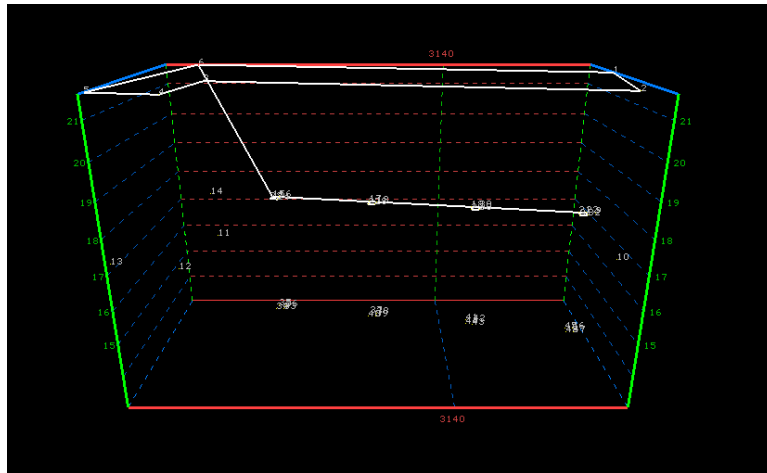

Figure 4.4 Imported data of the created object

A second attempt was performed with the creation of two CoordGeom with attaching different elevations values (Figure 4.5).

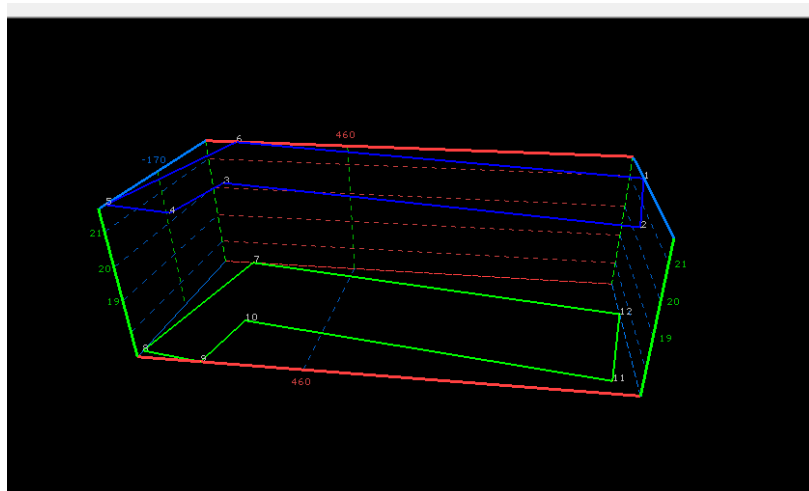

Figure 4.5 Other object created of the Survey Plan

This file was then exported into LandXML and then imported into a new CivilCAD file. When the LandXML file was imported back into CivilCAD, only one of the CoordGeom was visible. Both CoordGeom were created in different separate layers and attributes were carried through the exporting and importing stages.

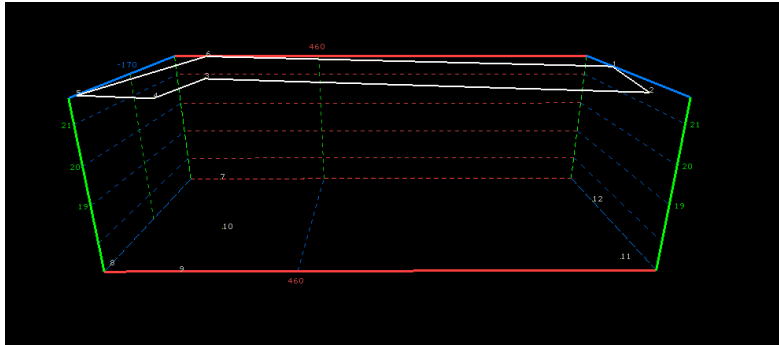

Figure 4.6 Data exported into LandXML and then imported back into CivilCAD

The starting and ending point were stored within the LandXML script in the element GeomCoord. This could be seen in the LandXML file which was produced with CivilCAD. This could also be due to the software limitations not expecting the second CoordGeom due to the 'pass' and 'fail'. The first CoordGeom which was on the LandXML script was a pass, however due to the possible software ability to understand the LandXML file, the second script was a 'fail' and therefore it was not imported.

4.2.1.2 Trimble Business Centre

The creation of the parcel using lines and points (Figure 4.7) using Trimble Business Centre was completed. This allowed the parcel to be 'watertight' (Figure 4.8), meaning the CoordGeom was fully closed with CoordGeom's making a full boundary of the object.

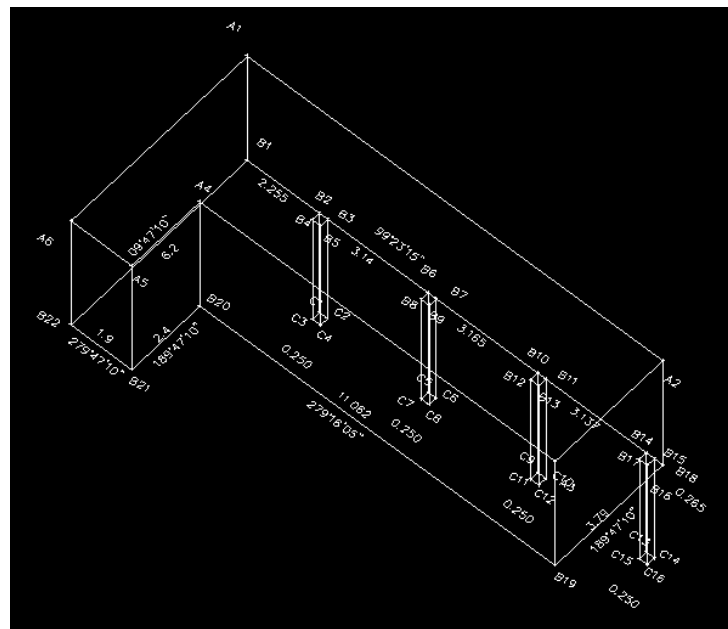

Figure 4.7 3D view of the boundary lot

The created 'CoordGeoms' was then able to be viewed as a 3D object.

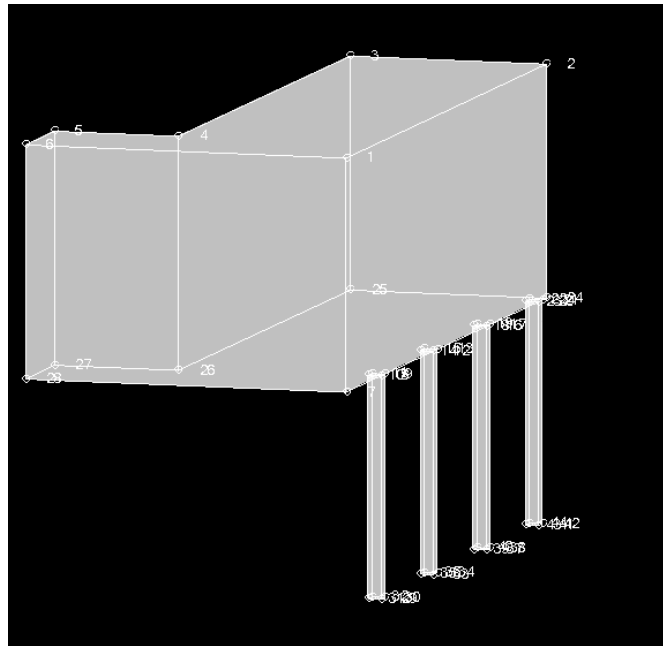

Figure 4.8 3D view of the fully closed boundary lot

The CoordGeom was created using points, lines and polygons, which illustrated a real representation of the object (Figure 4.8). Different layers were created for the points, lines and polygons to analyse the ability to export and transform these attributes into LandXML.

The imported LandXML file contained 'CgPoints' in, however, the 'CoordGeom' were not imported (Figure 4.9) in the LandXML file. The points were confirmed with the original coordinates and found to be accurate.

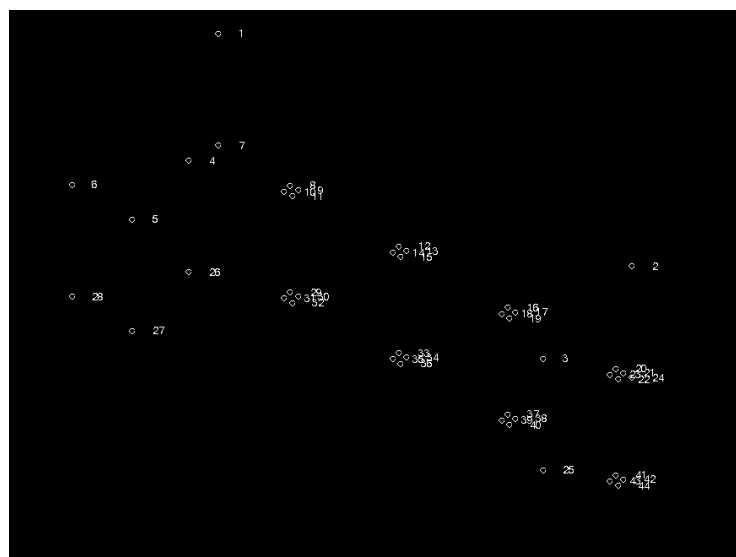

Figure 4.9 Cg_points from imported LandXML file in 3D view

4.2.1.3 AutoCAD

AutoCAD software package was used to create the parcel/Lot, with specifying different layers (Figure 4.10). The ability to create a true representation of the Lot was achieved and was viewed in 3D (Figure 4.11). Civil3D, which is also an AutoDesk application, was used to view the data.

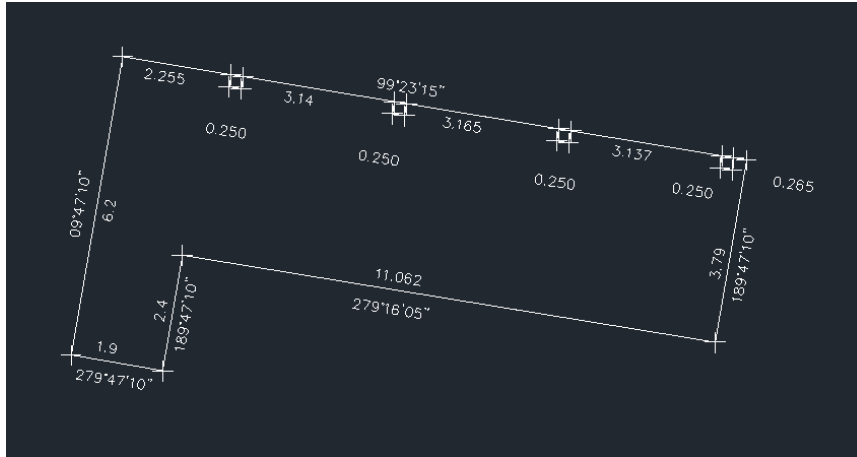

Figure 4.10 Case study SP2134992 2D view using AutoCAD

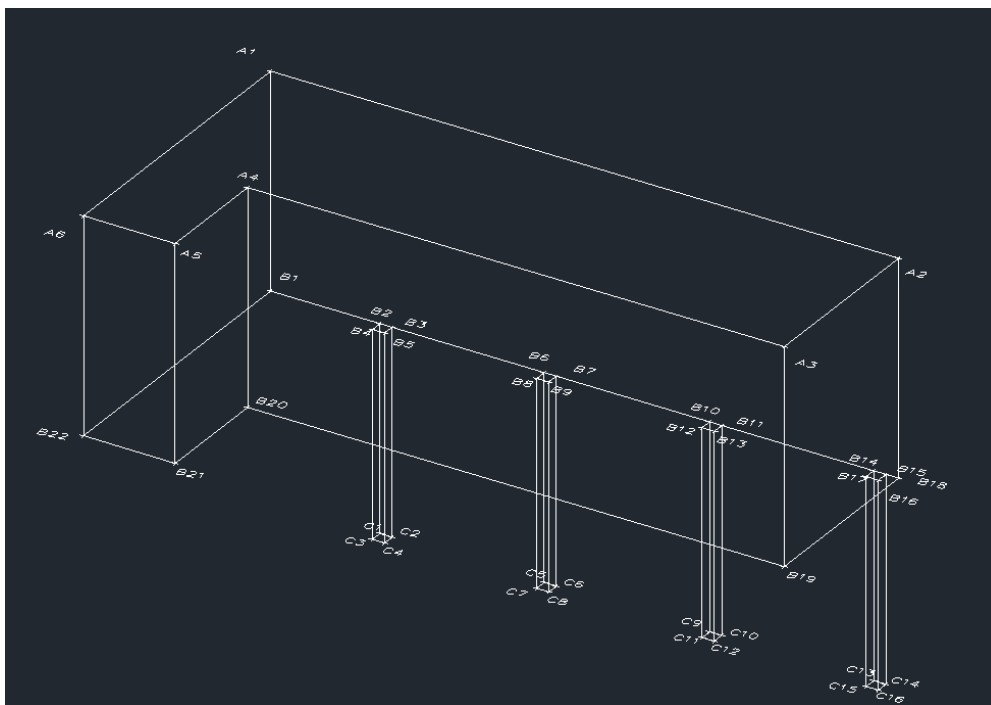

Figure 4.11 3D Isometric view of objects

A second 'true representation' lot was created with the LandXML add-on for AutoCAD (Figure 4.11).

Exported data did not contain any 'CoordGeom' elements; however, the points which were imported only contained 2D values. The use of AutoCAD Civil 3D was used for the importing of the file (Figure 4.12).

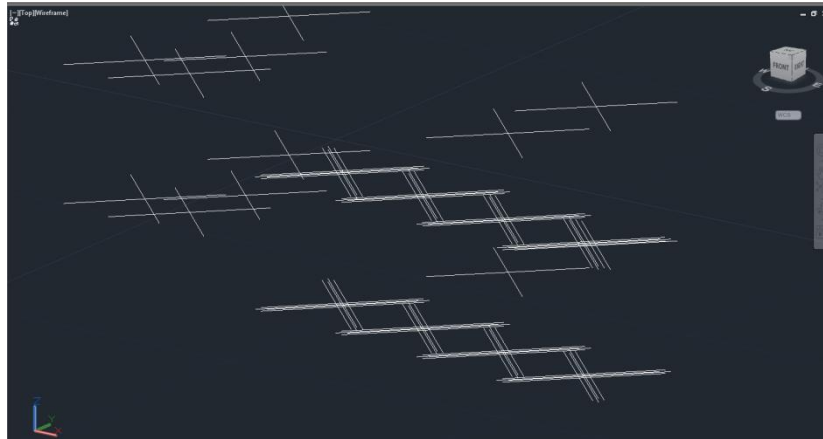

Figure 4.12 Using Civil3D to export and import the LandXML file

Second version of AutoCAD with the add on

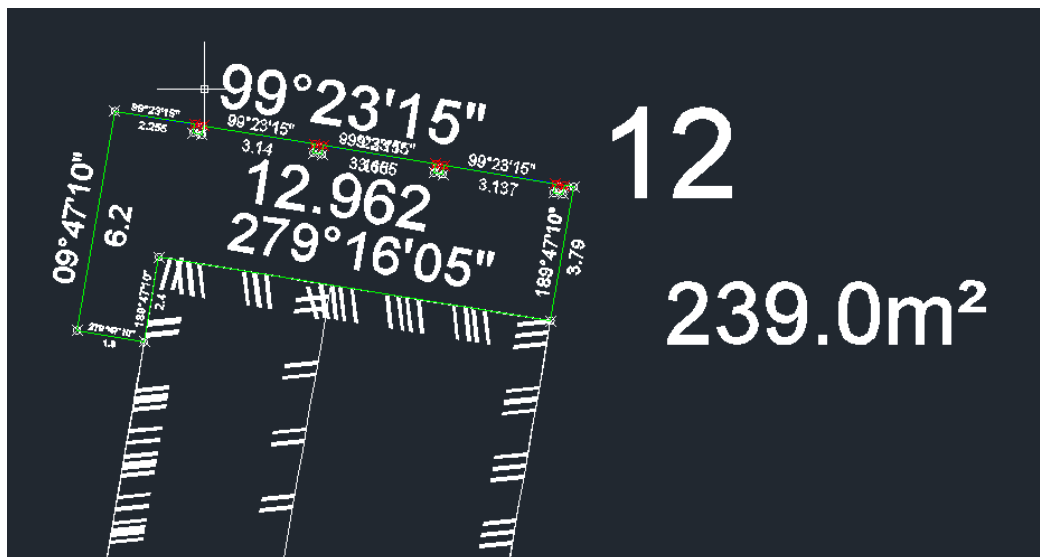

Figure 4.13 2D version with the AutoCAD add on

The ability to create a representation of the lot with elevation values was completed. However, when the lot was creation with AutoCAD it was only visualised in 2D (Figure 4.13).

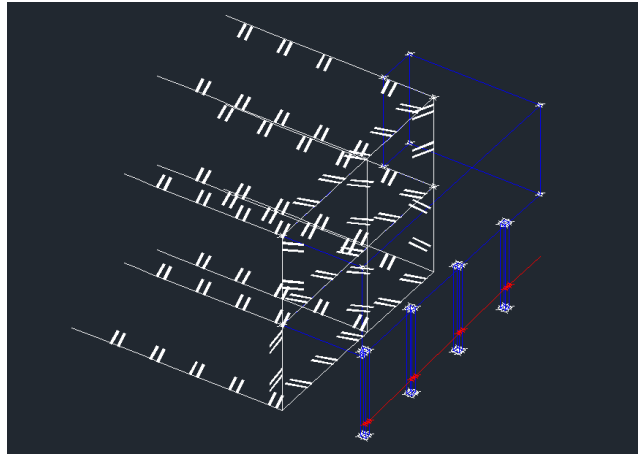

Figure 4.14 Objects represented in 3D Isometric views using different colour

The representation of the parcel in 3D isometric view was completed (Figure 4.14) attaching more information to the data. This was due to the internal validation associated with the “add-on (LandXMLA4C)” which did not allow the exporting of LandXML data until certain requirements were satisfied. In addition to this, the built-in Layer, which also has the required attributes, was automatically attached. However, the lot was unable to be created with high elevation or a vertical ‘CoordGeom’. This means that the parcel was not completed as a ‘watertight’ lot (Figure 4.15).

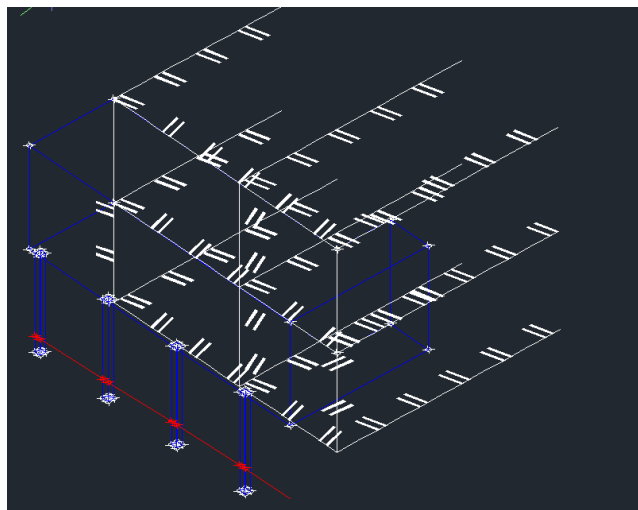

Figure 4.15 Alternate 3D isometric view

LandXMLA4C data was imported with the use of the add-on function. The imported LandXML data contained the required attributes (Figure 4.16). This information was visible when the data was imported.

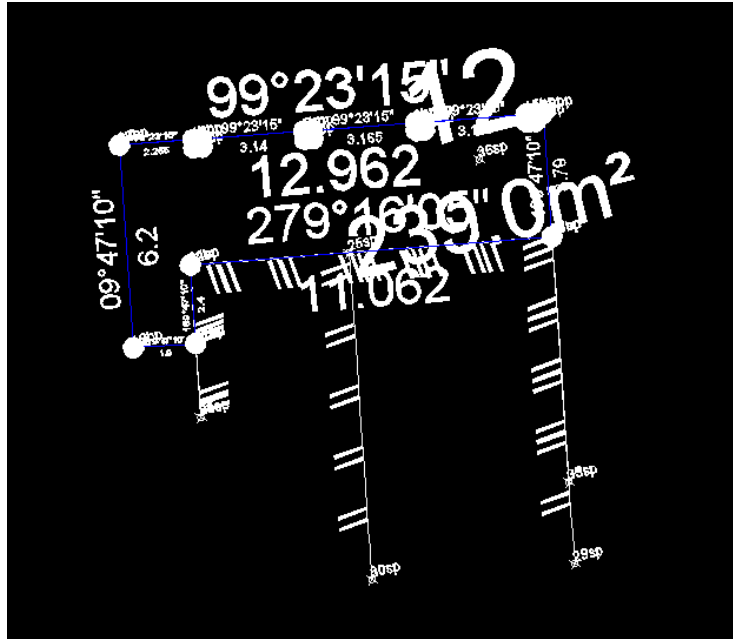

Figure 4.16 Imported AutoCAD add on file in 2D

However, the imported data set did not contain the height values created in the first phase (Figure 4.17). Cross referencing of the coordinates showed that the coordinate's areas were accurate.

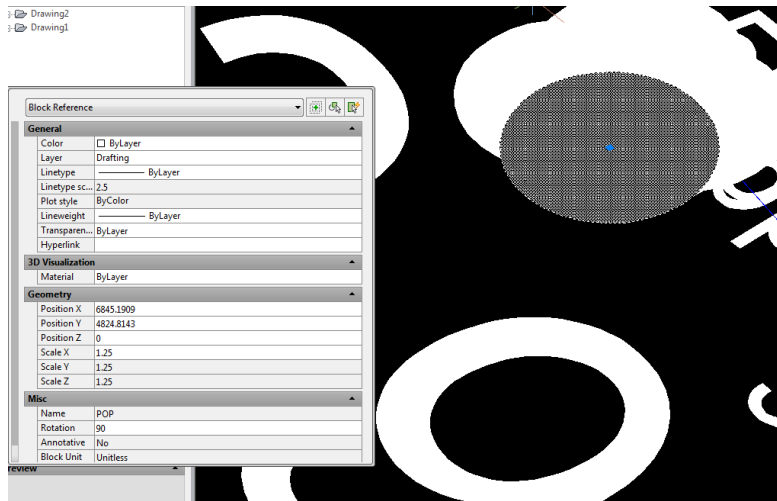

Figure 4.17 CgPoints not imported with elevation values

4.2.2 Survey Plan II (SP116505)

This Section discusses the creation of the Survey Plan II (SP213499) using three different CAD software packages.

4.2.2.1 CivilCAD

The creation of circles to represent the cylindrical lots with 'CoordGeom' was attempted using

CivilCAD software. When creating the arcs, elevation attributes could not be attached. Therefore, the method of using two arcs to create a circle was attempted (Figure 4.18).



Figure 4.18 Created attributes of the arc in CivilCAD

However, the Lot was not viewed in 3D viewer (Figure 4.19). 'CoordGeom' did not close the object making it a full boundary. Arcs were only created using CivilCAD software. This gave a low representation/visualisation of the parcel and it was only visualised as layered arcs. This did not allow to create lines which would run vertically up along with the communication poles and would close the parcels of the object.

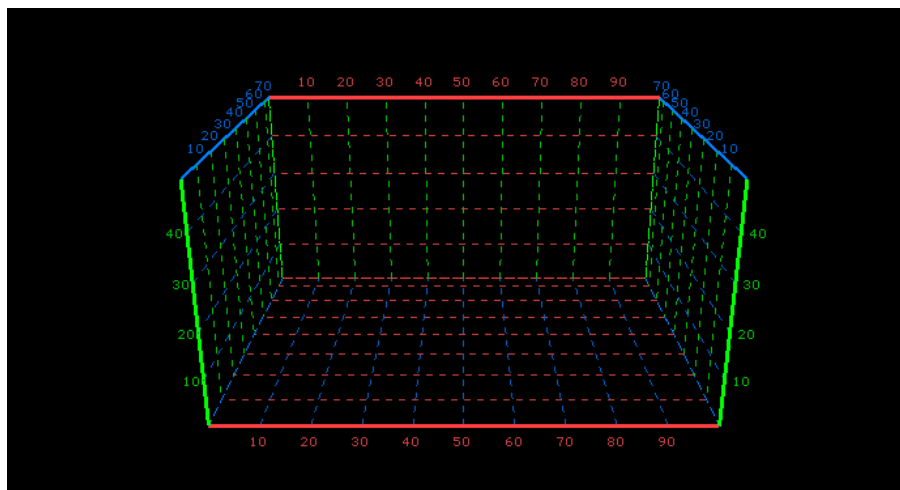

Figure 4.19 3D viewer un able to view the created parcel

Imported LandXML data contained 2D arcs which represented the lower doughnut of the lot. Therefore, the points which were connected to the arcs carried only the 2D value (Figure 4.18). The only point which was created was the centre containing 3D values. This causes an incapability of the software to view the lot in the 3D viewer (Figure 4.20).

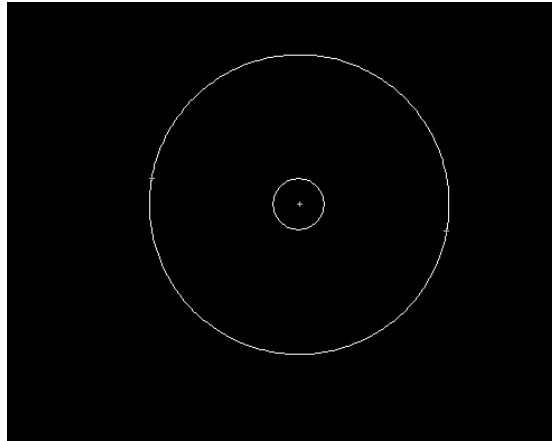

Figure 4.20 Created doughnut parcel in CivilCAD

4.2.2.2 Trimble Business Centre

'CoordGeoms' with height values were created and viewed in 3D (see Figure 4.21) using Trimble Business Centre.

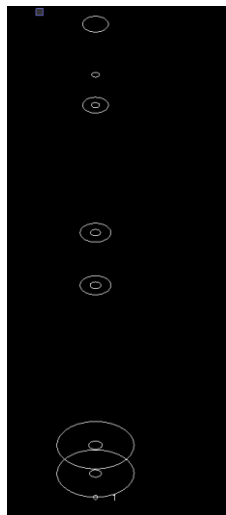

Figure 4.21 The representation of the LA_BoundaryFace and the object in 3D

'CoordGeoms' which ran vertically down the objects were also created. This gave a real representation of the 3D spatial object using points and lines, which was then closed forming the 3D surface (Figure 4.22). This gave a good 3D visualisation of the object as illustrated in Figure 4.22. However, the ability to create a lot in 3D and to generate the cylindrical shape was not completed.

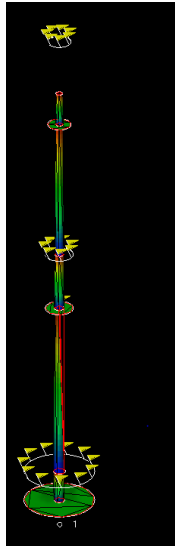

Figure 4.22 Surface with LA_BoundaryFaceStrings in 3D view

The Lot was represented as a 3D spatial object using the Trimble Business Centre. This software has a capability to create different points and lines using layers attached option.

By creating a 3D surface, a good visualisation of that lot into 3D form was represented. However, it did not show the top of the Doughnut Lots and only showed the bottom face of the lots. Though the surface was well represented, the 'CoordGeom' and Lots were not truly visualised (Figure 4.23). Only 'CgPoints' where imported.

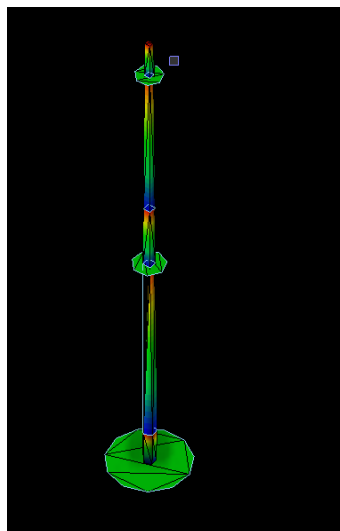

Figure 4.23 Imported LandXML into Trimble Business Centre

4.2.2.3 AutoCAD

The creation of circle was completed using the cylinder function within AutoCAD software, and could be seen by the creation of the 'CoordGeom' and true representation of the Doughnut Lots (Figure

4.24). This could also be seen in 2D (Figure 4.25) where the circle alignment was correct. However, there was poor representation of the parcel as a whole. Without the use of the 3D view, it would be hard to understand the order of the Doughnut Lots.

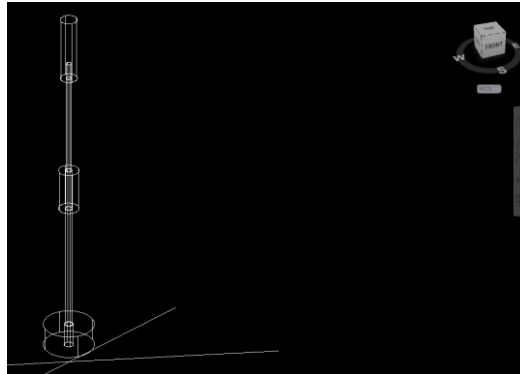

Figure 4.24 Created file using AutoCAD Civil 3D

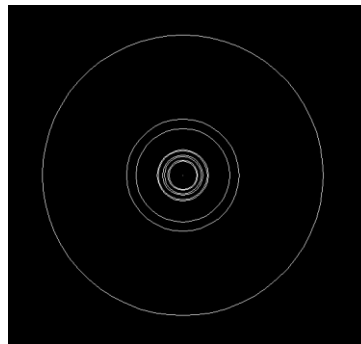

Figure 4.25 2D View of the doughnut lots

The cylinder function was suitable for the creation of the Doughnut Lots, however, it was not satisfactory for the shaft which ran down the centre of the lots. This was due to the fact that the shaft changed its diameter as the elevation changed, and the cylinder function did not have the ability to compensate for these changes. This created gaps where the shaft was connected to the Doughnut Lots (Figures 4.26 and 4.27).

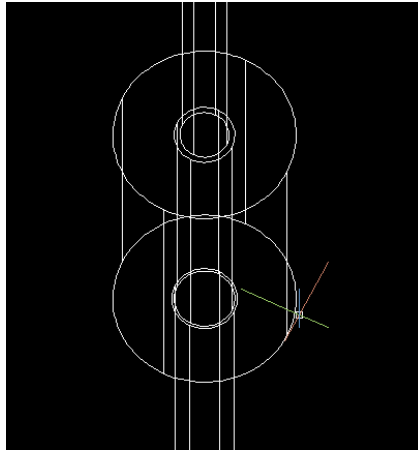

Figure 4.26 3D view of the central shaft connects with the middle doughnut Lot

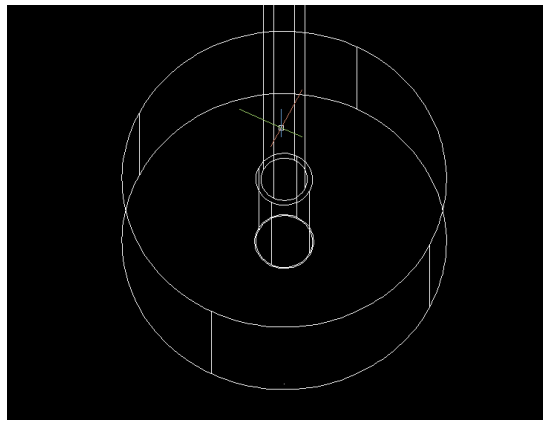

Figure 4.27 Gaps in between the lots, not creating a full boundary

With the use of the AutoCAD and LandXML4AC the lots were created with 'CoordGeom'. Lots were created for the Doughnut parcels but no elevation attributes were able to be attached. The centre shaft was not created as a cylinder, however, for the purpose of representation; vertical lines were created (Figure 4.27).

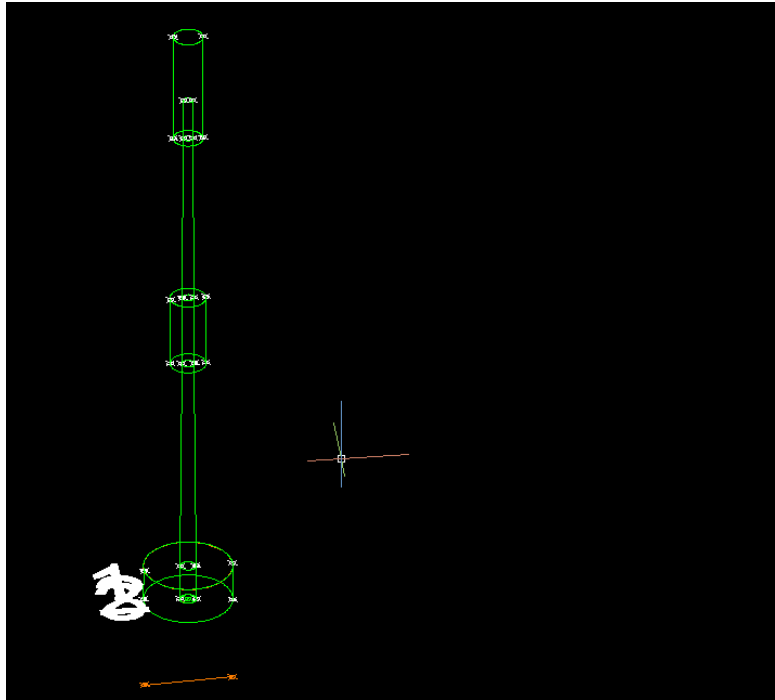

Figure 4.28 An unclosed parcel made with AutoCaD add-on

The LandXML file was imported using the LANDXMLA4C function. The imported file contained the lot, however, no elevation values were attached. Not all of the 'CoordGeoms' which were imported could be seen and the imported files were not correctly represented.

4.3 Exporting into LandXML File

In the exporting stage, the purpose was to check the ability of the CAD program to export LandXML data. The LandXML data were exported using CAD program with required values. Different layers were created to the data to check the required functions which were set out in ISO19152/ePlan standards.

4.3.1 Survey Plan I (SP213499)

SP213499 survey plan was selected and evaluated first. The schema was designed for different attributes such as lines, points, curves, survey header, CoordGeom, CgPoints and surface and the expected outcomes were noted. Comments were made based on the ability to produce the required data. Windows Explorer was used to visualise the LandXML data.

4.3.1.1 CivilCAD

Examination of the exported LandXML showed that the coordinates of the points were stored as CgPoints. CgPoints were made up of both horizontal and vertical values, which were confirmed as accurate for CAD. Lines and polygons were created and could be visualised using LandXML. LA_BoundaryFaceString's were stored using CoordGeom and used locations in 2D to get the start

and finish positions of a line. Lines were attached to a start and finish position with height values.

Table 4.1 shows the Schema 1.2 with following attributes and outcomes.

Schema 1.2			
Attributes	Expected Outcomes	Actual Outcomes	Comments
Line	Error	Mixed	Horizontal lines were correct but once height values were added, the results were varied.
Survey Header	Not complete	None	None
Surface	Not complete	None	None
CoordGeom	Completed	Mixed	Parcel was created.
PntList2D	Not complete	None	None
PntList3D	Not complete	None	None
CgPoints	complete	Exported	Exported with 3D values.
Parcel	Not complete	None	None
Curve	Not complete	None	None

Table 2.1 Comparing the exported data from AutoCAD software (SP213499)

4.3.1.2 Trimble Business Centre

Examination of LandXML files illustrated that the ‘CoordGeoms’ were not exported. Further investigation into the export function using the Trimble Business Centre showed that, even though they were selected, Trimble Business Centre issued an error and was unable to complete the tasks. Accuracy of points was confirmed by comparing with the CAD file. Table 4.2 shows the Schema 1.2 which contains different attributes and the outcomes.

Schema 1.2			
Attributes	Expected Outcomes	Actual Outcomes	Comments
Line	Error	None	Error occurred during export stage.

Survey Header	Not complete	None	None
Surface	Error	None	Error during export stage.
CoordGeom	Error	None	Error during export stage.
PntList2D	Not complete	None	None
PntList3D	Not complete	None	None
CgPoints	Completed	Exported	Exported with elevation values.
Parcel	Error	None	None
Curve	None	None	None

Table 4.2 Comparing the exported data from Trimble Business Centre to schema (SP213499)

4.3.1.3 AutoCAD

Using AutoCAD Civil 3D, both lines and points were exported. CgPoints had height elevation attributes and these were established as being correct according to the created CAD file. LA_BoundaryFaceString which were created were exported as a CoordGeom. Both bearings and length of the lines were described in the file. However, as in CivilCAD, the start and end of lines have only been described in 2D, with no elevation values.

The LandXML4AC1 package has an internal validation procedure before the users export data into LandXML. Due to this validation procedure, it is presumed that the specifications of LPI NSW were met. This could be verified and seen with the pntSurv = 'boundary' and state = 'proposed' which was attached to the CgPoint. Table 4.3 shows the Schema 1.2 and different attributes with expected as well as actual outcomes. The comments were made to clarify the outcomes.

Schema 1.2			
Attributes	Expected Outcomes	Actual Outcomes	Comments
Line	Completed	Mixed	Some of the height elevations were mixed up. Not true representation of parcel was presented.
Survey Header	Completed	Exported	Requirements for export to LandXML files were based on the completion of admin requirements.
Surface	Not	None	None

	complete		
CoordGeom	Completed	Mixed	Completed. No elevation values were exported.
PntList2D	Completed	Exported	Was used for lots. No elevation values were exported.
PntList3D	Not complete	None	None
CgPoints	Completed	Exported	Exported with no elevation values.
Parcel	Completed	Exported	Exported with no elevation values.
Curve	None	None	None

Table 4.3 Comparing the exported data from CivilCAD to schema (SP213499)

4.3.2 SP116505

4.3.2.1 CivilCAD

Examination of the LandXML file showed that the created points and arcs were both successfully exported from LandXML. However, when compared to the exported LandXML file for SP213499 which have CgPoints with elevation values, the file representing SP116505 did not create CgPoints with height values other than at Point 5. Further investigation showed that CgPoint `5` is the centre of the radius from which the arcs were created. The other points were attached to the arcs which provided the arc a start and end point. Arcs were stored in a similar way to the lines, with a start and end position which was in 2D. It was expected that the arcs would have similar outcomes to the lines which have 2D start and end position. Table 4.4 shows the Schema 1.2 which contains the different attributes and expected as well as actual outcomes. The comments were also noted.

Schema 1.2			
Attributes	Expected Outcomes	Actual Outcomes	Comments
Line	Error	Mixed	Some of the height values (elevations) were mixed up. Not true representation of parcel was presented.
Survey Header	Not completed	None	None
Surface	Not completed	None	None
CoordGeom	Not	None	None

	completed		
PntList2D	Completed	Exported	Exported file attached to the curve
PntList3D	Not complete	None	None
CgPoints	Completed	Exported	Exported with elevation values
Parcel	Not completed	None	None
Curve	Completed	Exported	No elevation values

Table 4.4 Comparing the exported data from CivilCAD (SP116505)

4.3.2.2 Trimble Business Centre

Because the surface was used to visualise the Lot, only one point was created. This CgPoint was the centre of the radius of the arcs which was used to create them. With the use of the surface, ids were created with height values stored in the LandXML. Table 4.5 illustrates the Schema 1.2 which contains the following attributes, outcomes and comments.

Schema 1.2			
Attributes	Expected Outcomes	Actual Outcomes	Comments
Line	Error	None	Error during export stage
Survey Header	Not complete	none	none
Surface	Completed	Completed	Some issues with the overlapping Doughnut parcels
CoordGeom	Error	None	Error during export stage
PntList2D	Not complete	None	None
PntList3D	Not complete	None	None
CgPoints	Completed	Exported	Exported with elevation values
Parcel	Error	None	None
Curve	None	None	None

Table 4.5 Comparing the exported data from Trimble Business Centre to schema (SP116505)

4.3.2.3 AutoCAD

The CAD file used the cylinder function of AutoCAD to create the Lot. Upon inspection of the LandXML file, none of the attributes of the parcel were exported. Further testing of the AutoCAD was done with the LandXML4AC add-on. It was found that the exported LandXML file contained CgPoint attributes without elevation values. The lot which was created was attached to pntRef. This could be seen with the Lot being described with an arc. Table 4.6 shows the following attributes outcomes, and comments.

Schema 1.2			
Attributes	Expected	Outcome	Comments
Line	Completed	Mixed	Some of the height values (elevations) were mixed up. Not true representation of parcel presented.
Survey Header	Completed	Exported	Requirements for export to LandXML was completion of admin requirements
Surface	Not completed	None	None
CoordGeom	Completed	Mixed	Completed. No elevation values exported.
PntList2D	Completed	Exported	For lots. No elevation values exported.
PntList3D	Not complete	None	None
CgPoints	Completed	Exported	Exported with no elevation values.
Parcel	Completed	Exported	Exported with no elevation values.
Curve	Completed	Exported	Exported with no elevation values.

Table 4.6 Comparing the exported data from AutoCAD to schema (SP116505)

4.4 eSurvey Rendering and Validation Phase

The exported LandXML data was uploaded onto the eSurvey web portal. This allowed the rendering and visualisation of the uploaded data which was compared with the exported data. Both validations of the data could ensure that correct representation of the object was examined during validation phase.

4.4.1 Case Studies

Both case studies were investigated together in this section. This was due to the repeated errors occurred from the case studies. Comments on the ability to represent the object in the CAD software packages were made. Parts of a SIP LandXML file were used for editing purposes. The SIP was

supplied by DNRM which was tested and passed through the eSurvey web portal for validation and rendering. The file has been used to add information into the created LandXML files from the CAD software. The information incorporated administration information such as survey header and purpose.

4.4.1.1 CivilCAD

The first attempt of rendering the LandXML file which was created with CivilCAD was a failed attempt. This was due to the lack of administrative attributes such as Survey Header. A second attempt was completed with an edited version of the file, which passed the validation. The contents of the file which related to the Lots were placed within the file. The new file contained the CgPoints and GeomCoords of two CivilCAD files including administrative data. This file was then entered into the eSurvey rendering web portal, which was re-opened. The LandXML file had three parcels which were reviewed in detail in CivilCAD creation Phase (Figure 4.3, Figure 4.4).



Figure 4.29 Preliminary validation of the CIF

The LandXML file was then entered into the eSurvey validation system to analyse the validation error. Once the file was uploaded on the eSurvey validation web portal, a validation report was generated. There was internal validation errors associated with to the parcel such as lack of orientation due to connections to permanent marks. These errors were not taken into account when the file was created. Table 4.7 shows the following outcomes.

Validation Errors	Description of Validation Rules	Comments
VR237	Survey marks (monuments) must comply to the following rules	Mark type is different for control mark 19958 with type of 'other'; mark in SCDB has a type of 'plaque'. This can be seen as error due to the editing of the LandXML files and

		inconsistencies between those two files.
VR109, VR114, VR173	Validate the first CTS (Community Titles Scheme)	When creating a first CT, the survey must create common property and the CTS must be named in the plan. Lack of meeting the eSurvey validation requirements in the Creation Phase.
VR026	Check consistency of previous plan description	The previous description of the plan identifies the lots being extinguished. Each parcel identified in the previous description must have a parcel record for an extinguished parcel in the file.
VR009	Validate consistency of plan description (created parcels)	A parcel of type 'created' must exist for each created parcel identified in the plan description by the parcel. The file cannot have a created parcel not contained in the plan description.
VR001	A purpose of survey is required	A survey with a purpose of 'Subdivision' must create a parcel of class lot, road or common property. None of these were entered in the LandXML file.
VR000	Check CIF against schema	Check that a CIF is valid XML, valid LandXML and confirm to the departments requirements for a CIF file. Checks attribute values are not empty, are valid enumerations where appropriate, checks conditional attributes, uniqueness constraints and action statement structure.

Table 4.7 Validation errors associated to CivilCAD

4.4.1.2 Trimble Business Centre

The LandXML files which were produced by Trimble Business Centre followed the steps similar which the LandXML files with CivilCAD Software had followed. The SP116505 case study which was replicated in Trimble Business Centre had a surface element attached to the LandXML file. This LandXML script when attached to LandXML file which has developed from the SIP was unable to be validated by the eSurvey web portal validation (Figure 3.6). Table 4.8 shows the following validation errors and validation rules.

Validation Errors	Description of Validation Rules	Comments
VR237	Survey marks (monuments) must comply to the following rules.	Mark type is different for control mark 19958 with type of 'other'; mark in SCDB has a type of 'plaque'. This can see as error due to the editing of the LandXML files and inconsistencies between the two files.
VR109, VR114, VR173	Validate the first CTS (Community titles scheme)	When creating a first CT, the survey must create common property and the CTS must be named in the plan. Lack of meeting the eSurvey validation requirements in the creation phase.
VR026	Check consistency of previous plan description	The previous description of the plan identifies the lots being extinguished. Each parcel identified in the previous description must have a parcel record for an extinguished parcel in the file.
VR009	Validate consistency of plan description (created parcels)	A parcel of type 'created' must exist for each created parcel

		identified in the plan description by the parcel. The file cannot have a created parcel not contained in the plan description
VR001	A purpose of survey is required	A survey with a purpose of 'Subdivision' must create a parcel of class Lot, road or common property. None of these were entered in the LandXML file.
VR000	Check CIF against schema	Check that a CIF is valid XML, valid LandXML and confirm to the Department's requirements for a CIF file. Checks attribute values are not empty, are valid enumerations where appropriate, checks conditional attributes, uniqueness constraints and action statement structure.

Table 4.8 Validation Errors associated with Trimble Business Centre

4.4.1.3 AutoCAD

The created AutoCAD LandXML file was not edited like the CivilCAD and Trimble Business Centre files. The raw LandXML file which was exported with LandXMLA4C was entered directly in the eSurvey web portal for validation. The file returned the same error as CivilCAD and Trimble Business Centre (Figure 4.29). Using the SIP LandXML file, the CgPoints, CoordGeom and Parcels elements were removed and replaced with the script which was produced by the LandXMIA4C add-on. No editing was done to tie the connections of parcels to the known control marks in the SCDB. An error could be expected as a result. The file was then uploaded into the eSurvey web portal validation system for the creation of validation report. The validation report produced some errors which were less than the created LandXML files from CivilCAD and Trimble business centre, though similar errors were occurred (Figure 4.30).

```

- <Error>
  <Type>Exception</Type>
  <Reason>CgPoint '35' does not have an associated monument.</Reason>
</Error>

```

Figure 4.30 Error of CgPoints from LandXMLA4C and edited LandXML file

When comparing the AutoCAD add on with LandXMLA4C, CivilCAD and Trimble Business Centre the errors were lower. With LandXMLA4C being accessible on the NSW government web portal, it could be assumed that it is primarily designed for NSW ePlan digital lodgement. This could be associated with the fact that NSW and QLD both have adopted the same standards. This would suggest lower errors and similar set out of the LandXML files. There were LandXMLA4C to add Queensland information to the CAD drawing. This was not investigated in the report. Table 4.9 illustrates the validation errors and validation rules.

Validation Errors	Description of Validation Rules	Comments
VR000	Check CIF against schema	Check that a CIF is valid XML, valid LandXML and confirms to the Department's requirements for a CIF file. Checks attribute values are not empty, are valid enumerations where appropriate, checks conditional attributes, uniqueness constraints and action statement structure.
VR089	Validate survey point persistent identifier	All pre-existing survey points must be linked to a persistent identifier greater than a million.
VR237	Validate Survey Control Marks	Survey marks (monuments) must comply with the following rules: (1) The control mark exists in SCDB (Fatal) (2) The mark type from SCDB and the CIF file are the same (Exception) (3) If the CIF shows the mark as new the SCDB

		should identify the mark as uninstalled. (Exception) (4) If the CIF shows the mark as any status but New then a record with an installed date in the SCDB must exist (Exception).
--	--	-----------------------------------------------------------------------------------------------------------------------------------------------------------------------------------

Table 4.9 Validation Errors associated with AutoCAD

4.5 Discussion of Results

The interpretations of the results documented in this chapter are made through the methods discussed in Chapter Three. Table 4.10 contains incorporated results of Chapter Four.

	Outcome
Line	Only limited LandXML data has been created from exporting CAD data. This can be the result of not fulfilling the necessary requirements set by the CAD software for the successful application. This can also be due to the exporting of LandXML function not being designed to complete the ePlan/ISO19152 standards. Data which was pulled from LandXMLA4C however did not fulfil some of the eSurvey requirements (Figures 49, 50)
Survey Header	Most CAD packages were not able to complete the required administrative data such as survey header (VR001) and surveyor's certification. There was expectation of having to incorporate LandXML data into the file for eSurvey to accept these file. However, this would only bypass the internal validation. The external validations of eSurvey such as VR026 check the consistency of previous plan description. Due to being unable to complete the requirements set out by the external validation, no rendering of the LandXML files was able to be completed.
Surface	The only surface which was created was SP116505 with Trimble Business Centre. This file was not able to be read with the eSurvey web portal validation.

CoordGeom	CivilCAD and AutoCAD LandXMLA4C were both able to create CoordGeom. Both, when added to an edited LandXML file, were able to validate. CoordGeom element held the required amount of information within the LandXML schema and this can be seen in the validation process.
PntList2D	No PntList2D was able to be created with the CAD software packages. The storing of 'parcels' and objects in LandXML was completed with GeomCoord.
PntList3D	No PntList3D was able to be created with the CAD software packages. The storing of 'parcels' and objects in LandXML were done with GeomCoord.
CgPoints	The ability to create CgPoints was completed with all CAD packages. However, in the scope of eSurvey, the amount of information was not sufficient or did not retain the correct layout.

Table 4.10 Results of the case studies

4.6 Conclusions

In this chapter, the two case studies were processed through each phase with three CAD software packages. The SP213499 case study had simpler definitions of legal object, and the CAD packages could therefore create a closer representation of the lot than the SP116505 study, allowing more of the software capabilities to be examined. All CAD packages performed better in 2D space, showing limitations when working in 3D.

Two validation steps were used to evaluate the output of the CAD packages. The internal validation checked the format and contents of the CIF for errors; the validation was passed if the contents met

the specified validation rules. The external validation compared CIF components (include title referencing, adjoining lots, etc.) with the DCDB, and returned an error if the components did not match. Of the three packages used in this project, AutoCAD was the only one software that has checked the internal validation, due to inclusion of ePlan standards within the LandXMLA4C add on. All external validation checks returned with errors, and there was no examination of software related errors, as there was insufficient time to resolve the user related errors.

Sufficient testing has been done to draw conclusions for all of the research questions as set out in the project methodology.

Chapter Five

5 Conclusion

The aim of this chapter is to summarise the outcomes of the research and reviews the achievements of research aim and objectives. This chapter also discusses the directions for future research.

5.1 Research Aim and Objectives

As discussed in the First Chapter, the overall aim of this project was to investigate the ability of LandXML for the definition of 3D spatial objects within the project of eSurvey project for 3D Cadastre implementation in Queensland.

In order to achieve the research aim, five research objectives were defined. The Four research objectives were addressed in Chapters Two, Three and Four. Chapter Two reviewed the general characteristics of 3D Cadastre, volumetric plan, eSurvey and LandXML. The current departmental procedures and standards for the digital lodgement of survey plan were discussed and the status of LandXML for digital lodgement within 3D Cadastre in Queensland was explored. Chapter Three framed the research method and Chapter Four determine the scope and limitations of LandXML taking the representative two cases from Queensland digital cadastral database (DCDB). This Chapter also evaluates the current capabilities of CAD software packages converting survey data into LandXML files. This Chapter also examines the current capabilities of eSurvey portal in rendering and validating of 3D related LandXML data. Chapter Five summaries the project findings and assess whether the project aim and objectives have been achieved or not.

The achievements of the objectives of the project are now reviewed and discussed in the following sections.

5.1.1 Objective 1

Investigate the status of LandXML for digital lodgement within 3D Cadastre in Queensland.

The available literature on the background of 3D Cadastre and electronic lodgement of survey data revealed that the eSurvey project has been initiated and LandXML has been adopted as a industry standards to exchange survey plan between registered surveyors and State Government Department in Queensland. In Chapter Two, the general characteristics of LandXML and the introduction of LandXML within the industry has been discussed. Two main standards related to 3D cadastre implementation were identified as ISO 19152 and ePlan. This chapter also discussed how

the future development of eSurvey will be affected by these standards. It has been identified that the Queensland legislation supports 3D cadastre and two survey Plans which supports the move into 3D cadastre are the volumetric plans and building format plans. LandXML has been used as a standard format of electronic survey data submission by ICSM and Queensland eSurvey project has used LandXML files. Other Digital Lodgement systems which are in practices within ICSM community were also explored. These systems gave similar outcomes when compared to ePlan.

The gathered information influenced the detailing of the project methodology.

5.1.2 Objective 2

Determine the scope and limitations of LandXML in two selected case studies.

The capabilities of LandXML were investigated through the case studies which have been discussed in Chapter Four. These capabilities were compared with the LandXML.org schema and tested through eSurvey web portal. The validation rules has been developed and tested with different attributes. Both case studies represented a legal object within Queensland Digital Cadastral Database and scope and limitations of LandXML has been explored. The capabilities of LandXML were not completely investigated through these two case studies due to the time and resource constraints. Limitations within the ability to produce LandXML files to represent the parcels can be explored further. Additional testing will be needed to be completed to ensure that the ability to hold and store the required 3D cadastral data.

5.1.3 Objective 3

Explore the scope and limitations of LandXML using current standards within 3D Cadastre.

The current capabilities of the LandXML to produce 3D cadastre are inconclusive. The testing within Chapter Three and Four showed that there is currently a limited amount LandXML data which can be exported. This was also seen with the ability to export and import data holding the required attachments in LandXML. However most of the CAD software packages were still creating data from Schema 1.2 and Schema 2.0 (currently being proposed), shows more supports for the ability of 3D Cadastre. Possible use of 3DCgPoints and 3DCgpointListing can be evaluated in future testing, however, much of the problem lies in defining a data model for 3D cadastre, the interactions with the existing database and data capture methods, and the range of possible shapes and combinations of 3D objects in existence at present and those likely to exist in the future (Karki et al, 2010).

5.1.4 Objective 4

Evaluate current capabilities of CAD software for LandXML.

Three CAD software packages were selected to reproduce LandXML files selecting the two case studies in Chapter Four. The representative cases were selected and 3D survey plan were created. The created CAD files were then exported into LandXML files and then imported as a new CAD files using the same CAD software. This allowed a confirmation of loss of data within the transformation into a LandXML file. This gave us a small snapshot of what are the capabilities of CAD software in the industry sectors. Further research has uncovered further development by CAD software towards the ability to produce LandXML files for digital lodgement, such as:

- Trimble Business Software has allocated resources for the development of exporting LandXML to fulfil the digital lodgement within Queensland;
- 12D has a current project in the development of LandXML abilities;
- LISCAD has already been used in the submissions of ePlan CIF within NSW and VIC.

It would have been preferred that the 12D and LISCAD packages should have used in the dissertation. Both packages claim to have the ability to create LandXML data for eSurvey. However, this has not been tested in this project.

5.1.5 Objective 5

Examine the current capabilities of eSurvey in rendering and validating of LandXML data.

The case studies were used to produce multiple LandXML files which were uploaded into the eSurvey web portal for validation. This examination (detailed in Section 4.4) revealed that the current capability of the eSurvey portal has the capabilities to validate LandXML files. , The validation rules have been defined and the different attributes were tested. This validation has been created with the standards which have been investigated in Chapter Two and also with the legislation and requirements of Queensland. This can also be seen in the edited LandXML data which was created both from a SIP and from CAD software, though the SIP and LandXML file (administration information) were completely validated. Once the data which was attached to the file was changed and did not represent the administration information, the external validation failed. The internal and external validation allows the protection of the DCDB and ensures no entry of corrupted data.

The capabilities of the eSurvey rendering system were not fully investigated. Additional testing would be needed to ensure the ability to render the LandXML data.

5.2 Contributions of this Research

The need for 3D cadastre in Queensland for legal representation offers many possibilities to establish ownership of objects crossing several parcels. For example, easements can be registered for public utilities such as the supply of water, gas, electricity, telecommunication facilities, and be drawn on volumetric survey plans with their own geometry.

This research has investigated the ability of CIF in the form of LandXML script and analysed its effectiveness and accuracy for the eSurvey project. This research has explored the effectiveness of CIF and its stability for future use in the legal representation of parcels.

The standards and requirements which have been investigated have real world applications. These implemented standards will support for the development of 3D Cadastre in the future. However, there is a gap between expected outcomes and actual outcomes.

5.3 Future Research

Within this investigation, some further issues could be identified as avenues for future research. The following issue are identified as possible area for future investigation.

5.3.1 3D Geometric Modelling

The ability to represent objects in 3D as a true representation of a 3D cadastre parcels needs to be explored. From current research of 3D geometric modelling have the current ideas ranges from:

- Primitive instancing
- Sweep presentations
- Boundary representations
- Spatial partitioning
- Constructive solid geometry.

If completed, there will be new capabilities in the visualisation of 3D Cadastre.

5.3.4 Use of 12D and LISCAD Software

5.3.5 Creation of Validation Rules for eSurvey Portal

5.4 Final Conclusions

This project has made a significant contribution towards the digital lodgement of 3D Survey Plan determining the existing factors preventing widespread implementation. This is a snapshot of current industry conditions, and may be changed in the future with the introduction of new software. The findings of this project can serve for the development of 3D cadastre in Queensland.

References

- AIEN, A, KALANTARI, M, RAJABIFARD, A, WILLIAMSON, I and BENNETT, R 2011a, 'Advanced Principles of 3D Cadastral Data Modelling', *2nd International Workshop on 3D Cadastres, Delft, the Netherlands*,
- Aien, A, Kalantari, M, Rajabifard, A, Williamson, I and Wallace, J 2013, 'Towards integration of 3D legal and physical objects in cadastral datamodels', *Land Use Policy*, vol 35, pp 140-154.
- Aien, A, Kalantari, M, Rajabifard, A, Williamson, IP and Shojaei, D 2012, 'DEVELOPING AND TESTING A 3D CADASTRAL DATA MODEL A CASE STUDY IN AUSTRALIA', *ISPRS Annals of the Photogrammetry, Remote Sensing and Spatial Information Sciences*, vol 1-4, no XXII ISPRS Congress,
- AIEN, A, RAJABIFARD, A, KALANTARI, M and WILIAMSON, I 2011b, 'Aspects of 3D Cadastre- A Case Study in Victoria', *FIG Working Week 2011*, vol Bridging the Gap between Cultures, no Marrakech, Morocco, 18-22 May 2011,
- AIEN, A, RAJABIFARD, A, KALANTARI, M, WILLIAMSON, I and SHOJAEI, D 2014, 'Review and Assessment of Current Cadastral Data Models for 3D Cadastral Applications', *FIG Congress 2014*, vol Engaging the Challenges, Enhancing the Relevance, no Kuala Lumpur, Malaysia, 16 – 21 June 2014,
- Australian Government Information Management Office 2006, 'Recommended XML Namespace Scheme For Australian Government Organizations ',
- Chrit Lemmen and Peter van Oosterom 2003, '3D Cadastres', *Computers Environment and Urban Systems*, vol 27, pp 337-343.
- Crompvoets, J 2006, '*National Spatial Data Clearinghouses: Worldwide Development and Impact*', Doctor of Philosophy, Wageningen University, Wageningen, The Netherlands.
- Cumerford, N 2010, 'The ICSM ePlan Protocol, Its Development, Evolution and Implementation', *FIG Congress 2010*, vol Facing the Challenges – Building the Capacity, no Sydney, Australia, 11-16 April 2010,
- Dönera, F, Thompsonb, R, Stoterd, J, Lemmenc, C, Hendrik Ploegerd and Peter van Oosteromd, SZ 2010, '4D cadastres: First analysis of legal, organizational, and technical impact—With a case study on utility networks', *Land Use Policy*, vol 27, pp 1068-1081.

- Falzon, K., & Williamson, I. (2001). Digital Lodgement of Cadastral Survey Data in Australia - Issues and Options. *The Australian Surveyor*, 46(1), pp 62-71. Retrieved from http://www.csdila.unimelb.edu.au/publication/journals/Digital_lodgement_of_cadastral_AustSurveyor.pdf
- GRANT, D, DYER, M and HAANEN, A 2014, 'A New Zealand Strategy for Cadastre 2034', *A New Zealand Strategy for Cadastre 2034*, vol FIG Congress 2014, no Engaging the Challenges - Enhancing the Relevance,
- Hespanha, J, Bennekou-Minnema, JV, Oosterom, PV and Lemman, C 2008, 'The model driven architecture approach applied to the land administration domain model version 1.1- with focus on constraints specified in the object constraint language', *Integrating Generations*, vol FIG Working Week 2008, no Stockholm, Sweden 14-19 June 2008,
- Ho, S, Rajabifard, A and Kalantari, M 2014, 'Invisible' constraints on 3D innovation in land administration: A case study on the city of Melbourne', *Land Use Policy*, vol 42, no 2015, pp 412-425.
- I, W and L, H 1978, 'Aspects of title surveys in Australia. ', *21st Australian Survey Congress*,
- ICSM 2014. *Electronic Lodgement and Transfer of Survey Data Working Group (ePlan)*. Available: <http://www.icsm.gov.au/eplan/> [2014, 26.10.2014].
- Intergovernmental Committee on Surveying and Mapping 2010a, 'ePlan Model.', *Intergovernmental committee on surveying and mapping.*,
- Intergovernmental Committee on Surveying and Mapping 2010b, 'ePlan Protocol LandXML Mapping', vol 2.1,
- Intergovernmental Committee on Surveying and Mapping 2010c, 'ePlan Protocol LandXML Mapping', *Intergovernmental committee on surveying and mapping*,
- Intergovernmental Committee on Surveying and Mapping 2010d, 'ePlan Protocol LandXML Structural Requirements', vol 1.0,
- Intergovernmental Committee on Surveying and Mapping 2010e, 'ePlan Protocol LandXML Structural Requirements.', *Intergovernmental Committee on Surveying and Mapping*,
- Karki, S 2013, '3D CADASTRE IMPLEMENTATION ISSUES IN AUSTRALIA', UNIVERSITY OF SOUTHERN QUEENSLAND.
- Karki, S, Thompson, R and McDougal, K 2010, 'Data validation in 3D cadastre',

Karki, S, Thompson, R and McDougall, K 2012, 'Development of Validation Rules to Support Digital Lodgement of 3D Cadastral Plans',

Karki, S, Thompson, R and McDougall, K 2013, 'Development of validation rules to support digital lodgement of 3D

cadastral plans', *Computers, Environment and Urban Systems*, vol 10, no 07,

Karki, S, Thomspson, R, McDougall, K, Cumerford, N, Oosterom, PV and Lemman, C 2011, 'ISO Land Administration Domain Model and LandXML in the Development of Digital Survey Plan Lodgement for 3D Cadastre in Australia', *International Workshop on 3D Cadastres*, vol 2,

Kazar, B, Kothuri, R, Oosterom, Pv and Ravada, S 2008, 'On Valid and Invalid Three-Dimensional Geometries', *Advances in 3D Geoinformation Systems*,

Lammeren, Rv, Houtkamp, J, Colijn, S, Hilferink, M and Bouwman, A 2010, 'Affective appraisal of 3D land use visualization', *Computers, Environment and Urban Systems*, vol 34, pp 465-475.

Land & Property Information 2015. *ePlan*. Land & Property Information. Available: http://www.lpi.nsw.gov.au/land_titles/eplan [2015, 01/06/2015].

LandXML.org 2015. *LandXML.org*. Available: <http://www.landxml.org/> [2014, 20.12.2014].

Lemmen, C and Oosterom, PDPv 2012, 'ISO 19152 – THE LAND ADMINISTRATION DOMAIN MODEL', *Christiaan Lemmen, 2Prof Dr Peter van Oosterom. Faculty of Earth Observation and Geo-Information Science (ITC), University of Twente*,

P.O. Box 217, 7500 AE Enschede, THE NETHERLANDS.

Delft University of Technology, OTB, Section GIS Technology, P.O. Box 5030, 2600 GA Delft, THE NETHERLANDS.

Netherlands Cadastre, Land Registry and Mapping Agency, Kadaster International

P.O. Box 9046, 7300 GH Apeldoorn, THE NETHERLANDS,

N.S.W Government 2015. *Digital ePlan*. Available: http://www.lpi.nsw.gov.au/land_titles/eplan/digital_eplan [2015, 11.07.2015].

NSW Government 2014, 'NSW Land XML Recipe', *Specifications for preparation of Deposited Plans in LandXML format for lodgment in LPI NSW*, vol 7.5.2,

OOSTEROM, PV, LEMMEN, C and UITERMARK, H 2012, 'ISO 19152:2012, Land Administration Domain Model published by ISO',

Oosterom, Pv, Stoter, J and Lemmen, C 2013, 'Modelling of 3D Cadastral Systems',

OOSTEROM, PV, STOTER, J, PLOEGER, H, LEMMEN, C, THOMPSON, R and KARKI, S 2014, 'Initial Analysis of the Second FIG 3D Cadastres Questionnaire Status in 2014 and Expectations for 2018', *4th International Workshop on 3D Cadastres*,

Open Geospatial Consortium Inc 2010, 'OpenGIS® Implementation Standard for Geographic information - Simple feature access - Part 2: SQL option',

Picco, J, Higgins, M, Sarib, R, Johnston, G and Blick, G 2006, 'Shaping the Change', *XXIII FIG Congress*, vol Munich, Germany, October 8-13, 2006,

Pouliot, J, Vasseur, M and Boubehrezh, A 2013, 'How the ISO 19152 Land Administration Domain Model performs in the comparison of cadastral systems: A case study of condominium/co-ownership in Quebec (Canada) and Isace Moselle (France)', *Computers, Environment and Urban Systems*, vol 40, pp 68-78.

RAJABIFARD, A, KALANTARI, M and WILLIAMSON, I 2012, 'Land and Property Information in 3D', *FIG Working Week 2012*, vol Knowing to manage the territory, protect the environment, evaluate the cultural heritage, no Rome, Italy, 6-10 May 2012,

Rodney James THOMPSON, AaPVO 2012, 'Validity of Mixed 2D and 3D Cadastral Parcels in the Land Administration Domain Model', *3rd International Workshop on 3D Cadastres: Developments and Practices*,

Roland Billena, Siyka Zlatanovab 2003, '3D spatial relationships model: a useful concept for 3D cadastre?', *Computers, Environment and Urban Systems*, vol 27, pp 411–425.

Shojaei, D, Kalantari, M, Bishop, ID, Rajabifard, A and Aien, A 2013, 'Visualization requirements for 3D cadastral systems', *Computers, Environment and Urban Systems*, vol 41, pp 39-54.

SHOJAEI, D, RAJABIFARD, A, KALANTARI, M, BISHOP, ID and AIEN, A 2012, 'Development of a 3D ePlan/LandXML Visualisation System in Australia', *3rd International Workshop on 3D Cadastres: Developments and Practices*, vol 25-26 October 2012, Shenzhen, China,

Soon, KH, Thompson, R and Khoo, V 2014, 'Semantics-based Fusion for CityGML and 3D LandXML', *4th International Workshop on 3D Cadastres*, vol 9-11 November 2014, Dubai, United Arab Emirates,

State of Queensland 2013a. *EARL validation CIF*. Available: <https://publications.qld.gov.au/storage/f/2014-09-24T04%3A25%3A35.354Z/earl-validate-cif-user-guide.pdf> [2015, 06.02.2015].

State of Queensland 2013b, 'EARL validation Rules',

State of Queensland 2014, 'QUEENSLAND INTERCHANGE FORMAT (QIF)', *DEPARTMENT OF NATURAL RESOURCES AND MINES*

SERVICE DELIVERY

LAND AND SPATIAL INFORMATION, vol 3.31,

State of Queensland 2015a,

State of Queensland 2015b, 27 February 2014. *Cadastral mapping of Queensland*. Available: <https://www.dnrm.qld.gov.au/mapping-data/maps/history/mapping/cadastral03/04/2015>].

Stoter, J and Oosterom, P 2005, 'Technological aspects of a full 3D cadastral registration', *International Journal of Geographical Information Science*, vol 19, no 6, pp 669-696.

Stotera, J and Salzmannb, M 2003, 'Towards a 3D cadastre: where do cadastral needs and technical possibilities meet', *Computers, Environment and Urban Systems*, vol 27, pp 395-410.

T. Badard and D. Richard 2001, 'Using XML for the exchange of updating information between geographical information systems', *Computers, Environment and Urban Systems*, vol 25, pp 17-31.

Telcík, T 2007, 'ICSM ePlan Model and CIF Jurisdictional XML Schema Review ', *Ajilon, Department of Lands*, vol 1.0,

Thompson, R and Van Oosterom, P 2008, 'Mathematically provable correct implementation of integrated 2D and 3D representations', *Advances in 3D geoinformation systems*, vol n P. Van Oosterom, S. Zlatanova, F. Penninga, & E. Fendel (Eds.), pp 247-278.

Thompson, R and van Oosterom, P 2012, 'Modelling and validation of 3D cadastral objects.', *Urban and Regional Data Management. UDMS Annual 2011*, no In S. Zlatanova, H. Ledoux, E. Fendel, & M. Rumor (Eds.),

Wady, V 2009, 'An Investigation of Land & Property Information (NSW) proposed E-Plan process of digital survey plan lodgement in LandXML format', University of Southern Queensland.

WILLIAMSON, I 2008, 'Using Cadastres to Support Sustainable Development', *International Federation of Surveyors*, vol Article of the Month, April 2008,

ENG4111/4112 Research Project

STUDENT:	Robert Hancock
TOPIC:	An Investigation into LandXML for implementation of 3D Cadastre in eSurvey
Supervisor:	Dr. Dev Paudyal
Enrolment:	Research Project ENG4111 Semester 1, 2015 Research Project ENG4112 Semester 2, 2015
Project Aim:	It is expected that this project will explore the suitability of LandXML within eSurvey project in Queensland and therefore improve the exchange of spatial data between surveyors and DNRM through digital lodgement.

Programme (Issue A, 4 March 2015):

1. Research literature related to the following (To be well-covered before **MAY** 2015):
 - a. General characteristics of EARL
 - b. 3D cadastral and volumetric plans within QLD
 - c. Characteristics of LandXML
 - d. Standards within the industry
 - e. Other digital lodgement using ePlan
2. Design a process to analyse data of the limitation of 3D Cadastre using LandXML (to be well-covered before **MAY** 2015). This step also requires the following:
 - a. Understanding industry standards to be used to compare results
 - b. Understand eSurvey validation process. Also how this will influence the outcome
3. Creation or collection of data to be analysed, preferable data which has an expected outcome to compare results from 3D geometric modelling
 - a. Collection of data by case study
 - b. Creation of case studies using selected CAD software
4. Analyse and produce results from results
 - a. Analyse results with industry standards and evaluate different outcomes
 - b. Compare results with Schema

5. AGREED:	Robert Hancock (Student)	Dr. Dev Paudyal (Supervisor)
	Date: 18/03/2015	Date: 18/03/2015
	Examiner/Co-examiner: _____ Date:	

Appendix B

Line

Modified to include official ID, as with all CoordGeom elements

Used By: CoordGeom

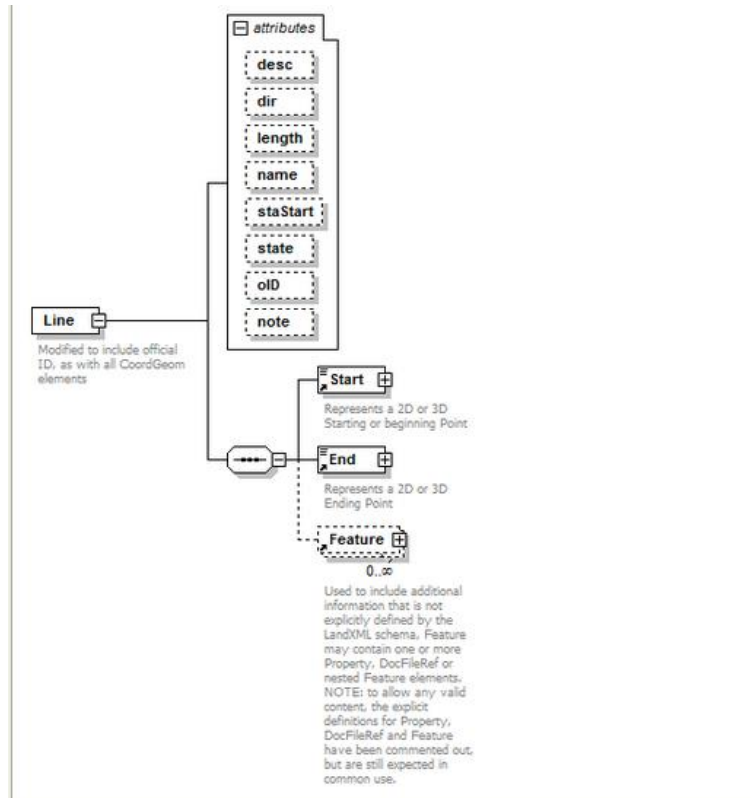

Survey Header

The Survey Header uses the following attributes to hold the necessary information:

<u>Name</u>	<u>Type</u>
name	xs:string
desc	xs:string
purpose	purposeType
startTime	xs:dateTime
endTime	xs:dateTime
surveyor	xs:string
surveyorFirm	xs:string
surveyorReference	xs:string
surveyorRegistration	xs:string

surveyPurpose	xs:string
type	surveyType
class	xs:string
county	xs:string
applyAtmosphericCorrection	xs:boolean
pressure	xs:double
temperature	xs:double
applySeaLevelCorrection	xs:boolean
scaleFactor	xs:double
seaLevelCorrectionFactor	xs:double
combinedFactor	xs:double
jurisdiction	jurisdictionType
submissionDate	xs:date
documentStatus	documentStatusType
surveyFormat	surveyFormatType
surveyStatus	surveyStatusType
communityTitleSchemeNo	xs:int
communityTitleSchemeName	xs:string
fieldNoteFlag	xs:boolean
fieldNoteReference	xs:string
fieldReport	xs:string

Table 3.3 Description of the attributes for Survey Header (LandXML.org, 2015)

Used By: Survey

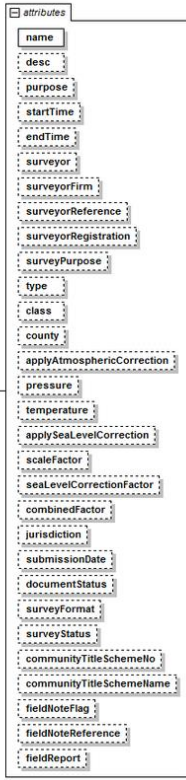

SurveyHeader

We seemed to have doubled up on the survey purpose here, but the two are quite different - maybe need a different name

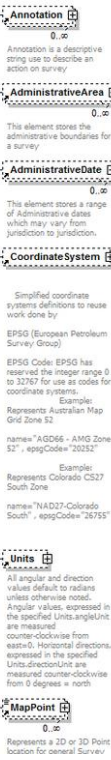

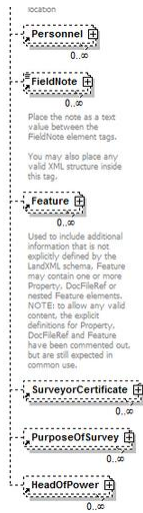

Surface

Definition is a collection of points and faces that define the surface.

Used By: Surfaces

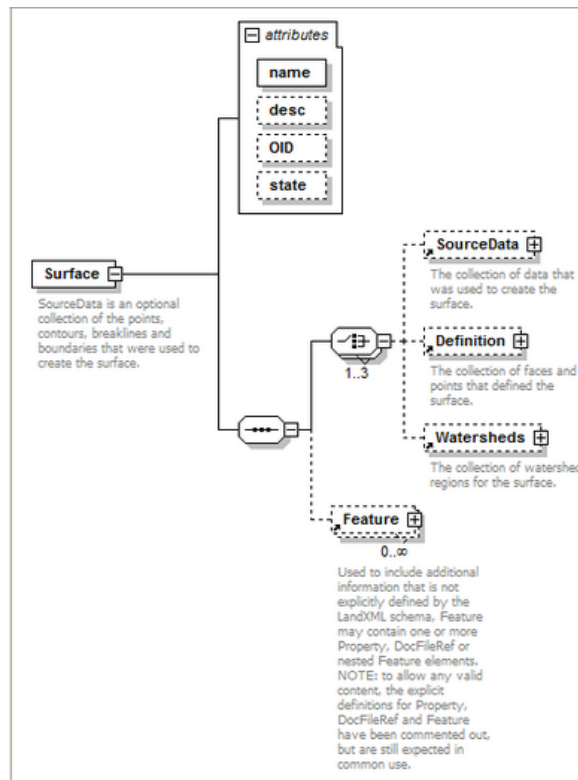

CoordGeom

After the sequential list of elements an optional vertical geometry may be defined as a profile, which may be as simple as a list of PVIs (point to point 3D line string)

Used By: Alignment, Parcel, PlanFeature, VolumeGeom

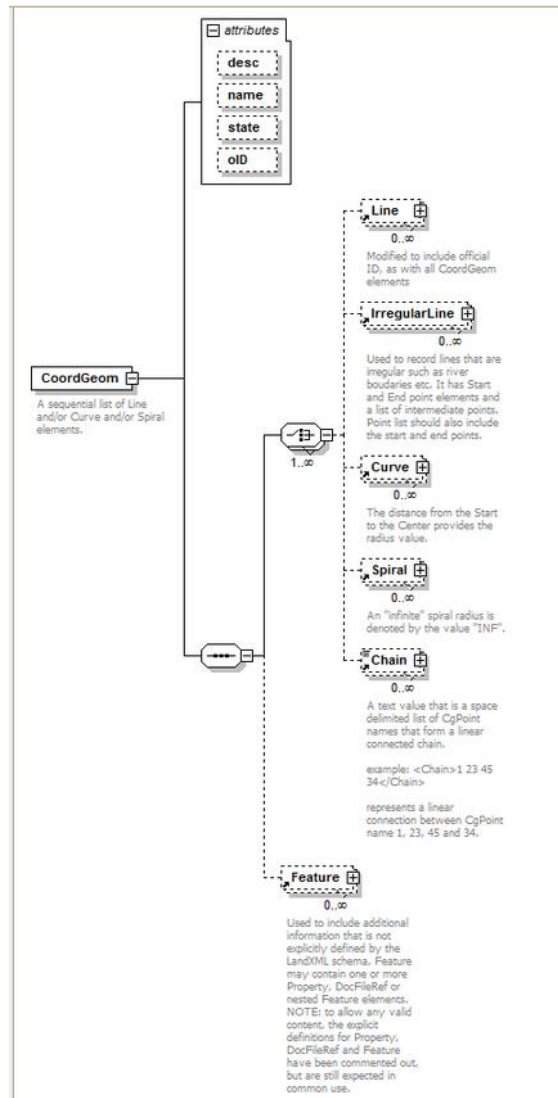

PntList2D

This is primarily used for ProfileSurf to hold the list of station/elevations and CrossSectSurf for offset/elevation.

Used By: Boundary, Breakline, Contour, CrossSectSurf, IrregularLine, ProfSurf, Watershed, ZoneCrossSectStructure

PntList3D

This is primarily used to store lists of northing/easting/elevation for Terrain Surface data.

Used By: Boundary, Breakline, DataPoints, IrregularLine, Watershed

CgPoints/CgPoint

CgPoints/CgPoints use the following attributes to hold the necessary information

<u>Name</u>	<u>Type</u>
name	xs:string
desc	xs:string
code	xs:string
state	<u>stateType</u>
pntRef	<u>pointNameRef</u>
featureRef	<u>featureNameRef</u>
pointGeometry	<u>pointGeometryType</u>
DTMAttribute	<u>DTMAttributeType</u>
timeStamp	xs:dateTime
role	<u>surveyRoleType</u>
determinedTimeStamp	xs:dateTime
ellipsoidHeight	<u>ellipsoidHeightType</u>
latitude	<u>latLongAngle</u>
longitude	<u>latLongAngle</u>
zone	xs:string
northingStdError	xs:double
eastingStdError	xs:double
elevationStdError	xs:double
oID	xs:string
surveyOrder	xs:string
pntSurv	<u>survPntType</u>
zoneNumber	<u>zoneNumberType</u>
surveyHorizontalOrder	xs:string
surveyVerticalOrder	xs:string
localUncertainty	xs:double
positionalUncertainty	xs:double

Table 3.4 Description of the attributes for CgPoints/CgPoint (LandXML.org, 2015)

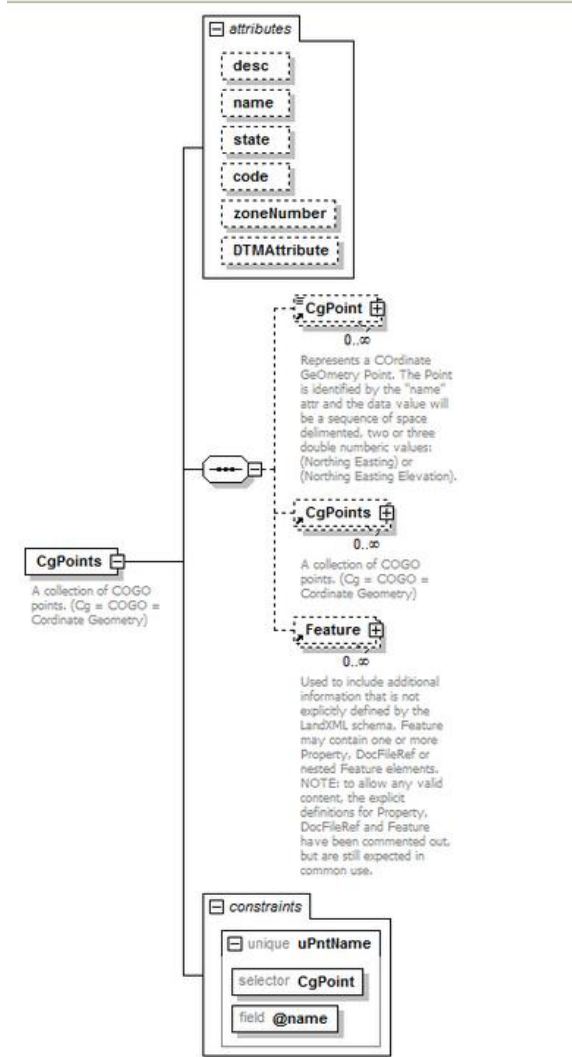
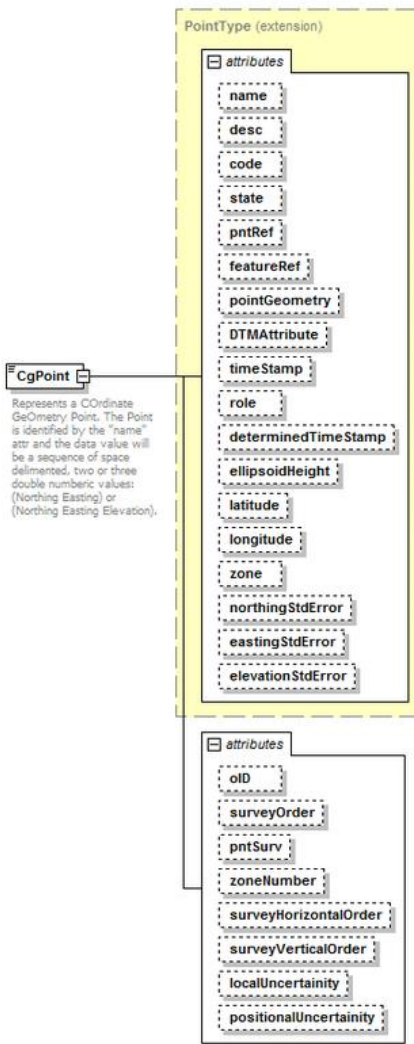

Parcel

Modified to include parcel class and an official ID

Used By: Parcels

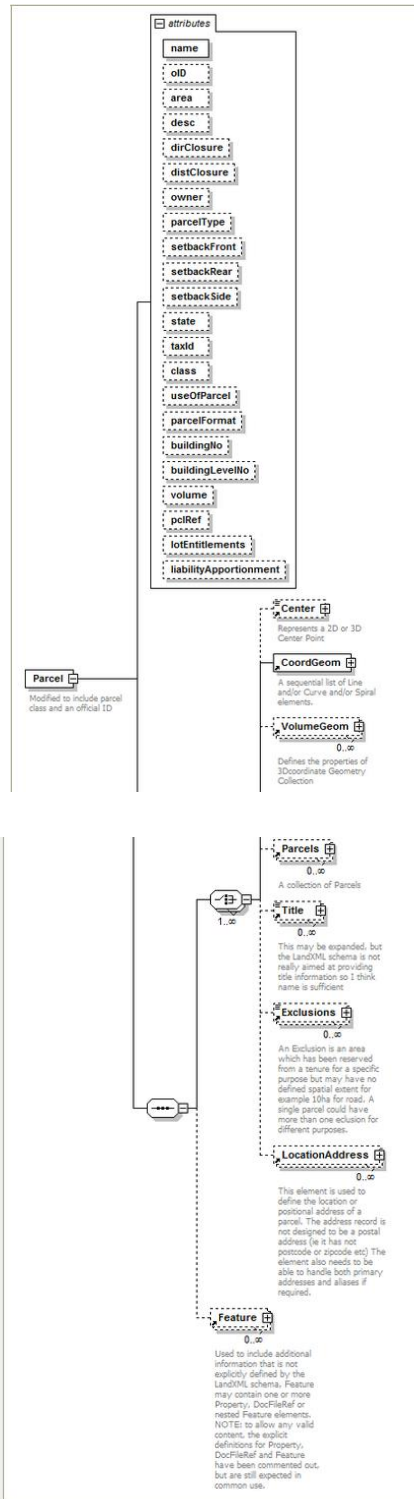

Curve

The rotation attribute "rot" defines whether the arc travels clockwise or counter-clockwise from the Start to End point.

Used By: CoordGeom, Curve1, Curve2

