

University of Southern Queensland
Faculty of Health, Engineering and Sciences

Wastewater Treatment using Tidal Flow Wetlands

A dissertation submitted by

Ms Ina Weinheimer

In fulfilment of the requirement of

Bachelor of Civil Engineering (Honours)

October 2015

ABSTRACT

Over the last century wastewater treatment has evolved immensely. This development is divided into two different ways of wastewater treatment. There are highly engineered wastewater treatment systems, which can achieve high treatment standards on a small area. And on the other hand there are natural treatment systems, such as constructed wetlands (CWs) that need large areas to achieve suitable treatment. Besides the difference of land area required by each of those systems they largely differ in the energy they require to perform such wastewater treatment.

This study investigates a new type of wastewater treatment system, the Tidal Flow Wetland (TFW). This system is part of a new generation of engineered treatment wetlands that aim to close the gap between highly engineered smaller systems and large CWs that treat wastewater naturally.

This study provides a comparison of different wastewater treatment options that are in direct competition to TFWs. It determines advantages and disadvantages of various systems for different situations. Furthermore a hypothetical wastewater situation for a small residential development has been developed to be able to compare a TFW and a conventional CW.

Overall the TFW achieved the same treatment standard to the hybrid conventional CW on less than a quarter of the area, while keeping energy consumption minimal. The results of the comparison also confirm the outstanding total nitrogen (TN) removal capability. While the TFW could achieve TN removal on only 24 m², the hybrid system required more than half of its total size (284 m² of 484 m²) for nitrate removal alone.

LIMITATIONS OF USE

The Council of the University of Southern Queensland, its Faculty of Health, Engineering & Sciences, and the staff of the University of Southern Queensland, do not accept any responsibility for the truth, accuracy or completeness of material contained within or associated with this dissertation.

Persons using all or any part of this material do so at their own risk, and not at the risk of the Council of the University of Southern Queensland, its Faculty of Health, Engineering & Sciences or the staff of the University of Southern Queensland.

This dissertation reports an educational exercise and has no purpose or validity beyond this exercise. The sole purpose of the course pair entitled “Research Project” is to contribute to the overall education within the student’s chosen degree program. This document, the associated hardware, software, drawings, and other material set out in the associated appendices should not be used for any other purpose: if they are so used, it is entirely at the risk of the user.

CANDIDATES CERTIFICATIONS

I certify that the ideas, designs and experimental work, results, analyses and conclusions set out in this dissertation are entirely my own effort, except where otherwise indicated and acknowledged.

I further certify that the work is original and has not been previously submitted for assessment in any other course or institution, except where specifically stated.

Ina Weinheimer

Student Number: W0100754

Signature:

Date:

ACKNOWLEDGEMENTS

This research was carried out under the principal supervision of Prof Jochen Bundschuh.

I would like to thank David Austin for answering my many questions via email and his advice on the topic.

I would also like to thank my partner Graham, my two daughters Milla and Hannah, and Helen Peden for supporting me during the time of this research.

TABLE OF CONTENT

ABSTRACT.....	i
LIMITATIONS OF USE	ii
CANDIDATES CERTIFICATIONS.....	iii
ACKNOWLEDGEMENTS	iv
TABLE OF CONTENT	v
LIST OF FIGURES.....	vii
LIST OF TABLES	viii
ABBREVIATIONS.....	ix
CHAPTER 1 - INTRODUCTION.....	1
1.1. Background.....	1
1.2. The Problem	1
1.3. Research Objectives	2
CHAPTER 2 - METHODOLOGY	3
CHAPTER 3 - LITERATURE REVIEW	4
3.1. History of Constructed Wetlands	4
3.2. Tidal Flow Constructed Wetlands.....	6
3.2.1. ReCip Tidal Flow System	7
3.2.2. Fill and Drain Tidal Flow Wetlands.....	10
3.3. Contaminants and Contaminant Removal in a TFAW.....	10
3.3.1. Nitrogen.....	10
3.3.2. Phosphorus	15
3.3.3. Suspended Solids.....	15
3.3.4. Biological Oxygen Demand.....	16
3.4. Clogging	16
3.5. Aggregate.....	17
3.6. Summary.....	17
CHAPTER 4 - CHARACTERIZATION, ANALYSIS AND COMPARISON OF CONSTRUCTED TREATMENT WETLANDS.....	19
4.1. Types of passive Constructed Wetlands.....	19

4.1.1.	Free Water Surface Wetlands.....	19
4.1.2.	Horizontal Sub-surface Flow Wetlands	21
4.1.3.	Vertical Sub-surface Flow Wetlands.....	22
4.1.1.	Hybrid Constructed Wetlands	23
4.1.2.	The French System Vertical Flow Constructed Wetland.....	23
4.2.	Aerated Artificial Wetlands.....	24
4.3.	Comparison of Alternative Treatment Systems to Tidal Flow CWs.....	25
4.3.1.	Comparison of Treatment Wetlands	25
4.3.2.	Comparison to Conventional Wastewater Treatment Systems	27
4.4.	Summary.....	29
CHAPTER 5 - COMPARISON OF A TIDAL FLOW WETLAND AND A PASSIVE (VF) WETLAND WHEN APPLIED TO WASTEWATER TREATMENT FOR A SMALL RESIDENTIAL DEVELOPMENT		31
5.1.	Introduction	31
5.2.	Wastewater Flow and Strength.....	31
5.3.	Treatment Target	32
5.4.	ReCip Tidal Flow Wetland.....	33
5.4.1.	Preliminary Sizing.....	33
5.4.2.	Energy Use	37
5.5.	Vertical Subsurface Flow Treatment Wetland	40
5.5.1.	Choosing an Appropriate Treatment Wetland	40
5.5.2.	Preliminary Sizing of the Wetland Area	40
5.5.3.	Energy Use	43
CHAPTER 6 - RESULTS		44
CHAPTER 7 - CONCLUSION		46
APPENDIX A - PROJECT SPECIFICATIONS		47
REFERENCES.....		48

LIST OF FIGURES

Figure 3.1: Types of Constructed Wetlands.....	6
Figure 3.2: Living Machines® Process Schematic	8
Figure 3.3: Recip Process Schematic	9
Figure 3.4: Simplified Nitrogen Removal Stages	12
Figure 3.5: Nitrogen Removal in a Tidal Flow Wetland Cell.....	14
Figure 4.1: Schematic FWS Constructed Wetland.....	20
Figure 4.2: Schematic HSSF Constructed Wetland	21
Figure 4.3: Schematic VF Constructed Wetland.....	22
Figure 4.4: French System Treatment Wetland Layout	24
Figure 4.5: System Schematics	28
Figure 4.6: Summary of Process Energy Requirements	29
Figure 4.7: Size vs. Energy Consumption On-Site Treatment Systems.....	30
Figure 5.1: Flow Diagram Tidal Flow Wetland.....	33
Figure 5.2: Layout of Tidal Flow Wetland	37
Figure 5.3: Layout Staged French System VF Wetland Followed by FWS Wetland.....	43

LIST OF TABLES

Table 1: Nitrogen Transformations in Wastewater Treatment/Constructed Wetlands	11
Table 2: Design and Operational Details on the 15 Treatment Systems at Langenreichenbach, Germany	26
Table 3: Comparison of Different Types of CWs	27
Table 4: Typical Composition of Municipal Wastewater and Percent Removal at Various Levels of Treatment	32

ABBREVIATIONS

TFW - Tidal Flow Wetland

CW - Constructed Wetland

HSSF - Horizontal Sub-Surface Flow

VF - Vertical Flow

FWS - Free Water Surface

N - Nitrogen

P - Phosphorus

TKN - Total Kjeldahl Nitrogen

TSS - Total Suspended Solids

BOD - Biological Oxygen Demand

EP - Equivalent Person

CHAPTER 1 - INTRODUCTION

1.1. Background

Over the last century wastewater treatment has evolved immensely. This development is divided into two different ways of wastewater treatment.

On one side are the highly engineered wastewater treatment systems like activated sludge and trickling filter systems that can achieve high treatment standards on a small area. To be able to achieve advanced treatment levels these systems use large amounts of energy.

On the other side are natural treatment systems like constructed wetlands (CWs). These systems use much larger areas and usually are not designed to achieve advanced treatment levels, but they use very little energy if at all.

Because of the low energy demand, the use of CWs as a treatment option has become increasingly popular around the world over the last 25 years. Research into improving the treatment performance of such systems has increased. This has led to the development of wastewater treatment systems that can close the gap between highly engineered energy intensive systems and natural low maintenance, low energy use CWs.

Tidal flow wetlands (TFWs) are one of those systems that are able to offer a compromise between energy use, treatment efficiency and area requirements. This is achieved by introducing additional oxygen to the wetland cell. In a tidal flow wetland this oxygen is added by introducing a tide to the wetland cell.

1.2. The Problem

Much research has been undertaken on the ability and limitations of TFWs over the last 15 years. These systems have been found to be a very promising approach for future applications so far. Total nitrogen (TN) removal in particular is a strength of TFWs. Most of the research so far undertaken has been done in a laboratory setting. Pilot studies and the detailed research into the most suitable applications of TFWs is still very limited.

1.3. Research Objectives

The purpose of this research was to identify and summarise the characteristics, advantages, and disadvantages of TFWs. The expected outcome from this study was a more thorough understanding of how TFWs work and which factors influence the design of TFWs in different ways. With this research it was aimed to determine possible future applications for this type of wastewater treatment.

The research methodology was divided into three main sections:

- a) Review relevant literature relating to TFWs and their performance
- b) Compare TFWs to other wastewater treatment options in direct competition to TFWs
- c) Set up a wastewater treatment situation to be able to directly compare TFWs and conventional CWs when applied to this specific situation
- d) Evaluate findings

More details on the research methodology can be found in chapter 2.

CHAPTER 2 - METHODOLOGY

The type of research undertaken in this study was a thorough review and evaluation of the current and past knowledge of TFWs as well as a basic evaluation of other conventional CWs that are in direct competition to TFWs. From the critical literature review and evaluation a comparison of TFWs and conventional CWs was possible. From this a direct comparison of a TFW and a conventional (passive) treatment wetland when applied to a small residential development was developed. This comparison together with the previous review, evaluation and comparison highlighted the possibilities, advantages and weaknesses of TFWs.

The comparison of the TFW with the conventional treatment wetland was based on a hypothetical wastewater situation. This means the comparison was undertaken in theory only and wetland characteristics and designs were based on calculations and assumptions. The most suitable type of TFW and setup of conventional CW was based on available literature and models. The chosen wetlands for this application are believed to be the best and most accurate options for this scenario.

The hypothetical wastewater situation used for this comparison was based on the climate of Southeast Queensland and a 100 EP residential development. Design criteria were based on literature where possible and where necessary on experience and knowledge of engineers that work in this field.

CHAPTER 3 - LITERATURE REVIEW

3.1. History of Constructed Wetlands

First developments and research into tidal flow wetlands started in the 1990s. The reason was that wastewater treatment using conventional constructed wetlands had limitations and researchers were trying to find a way to treat wastewater naturally to a higher treatment level while keeping the area footprint small and energy input low.

Surprisingly back in 1901 a US patent was filed that shows evidence of an engineered treatment wetland design using a similar approach to today's tidal flow wetlands (Monjeau 1901). Cleophas Monjeau's patent (1901) for a purifying water system hints that already over 100 years ago some engineers understood the basics of how tidal flow wetlands work (Austin 2003). It is not known if Monjeau's system was ever built. The main problem back then was the BOD load in wastewater. Trying to control the smell of the rivers was a priority. These types of systems had a limited BOD loading capacity, while trickling filters on the other hand had a much higher BOD treatment capacity and hence prevailed. Monjeau's design and similar approaches were soon forgotten.

In 1953, Dr Seidel of Max Planck Institute in Plon, Germany, first reported about the possibility of lessening the over-fertilisation, pollution, and silting up of inland waters through appropriate plants (Brix 1994a). Seidel conducted experiments on the possibility of wastewater treatment with wetland plants and her work is regarded as the origin of modern treatment wetlands (Hoffmann et al. 2011). Her findings, developments and first implementations form the 1st generation of treatment wetlands. Designs of these wetlands were based on experience, mainly, design standards were not yet developed. Further research was fuelled by successes and failures and 2nd generation wetlands developed out of the need to find a design standard for treatment wetlands. These first design criteria were based on the BOD loading per hectare of wetland. 2nd generation treatment wetlands were soon followed by a more detailed 3rd generation approach. Developers found that basing the design on BOD load alone was not sufficient. Different models emerged for the design of treatment wetlands that tried to fit input and output data to a model equation. The wetland itself is treated as a 'black box' with exact internal processes still mostly unknown. These 3rd generation design models are commonly used by wetland design engineers today. (Austin 2003)

These 1st, 2nd and 3rd generation approaches all have one thing in common - they are passive designs. This means that energy input is minimal if at all and the treatment of the wastewater relies on sunlight and atmospheric diffusion alone. (Austin 2003)

Since the 1990's the demand for constructed wetlands increased dramatically due to the rising cost of fossil fuels and an increasing concern about environmental protection and climate change (Lee, Fletcher & Sun 2009). Another reason for the increase in demand is the suitability of CWs to areas without a public sewage system and undeveloped countries, because they are able to be built out of locally available materials.

However, studies have shown that conventional types of CWs, although performing well for BOD, TSS and bacterial pollution, have limited capacity for nutrient removal especially nitrogen. Therefore these technologies alone have problems meeting strict discharge or reuse standards while still being considered an economical option.

Conventional CWs face two problems that prevent total nitrogen removal. Nitrogen removal is a two-step process, nitrification followed by denitrification. The first problem of conventional CWs is the oxygen supply associated with the first step, nitrification. Nitrification can only take place if sufficient oxygen is available in the wastewater. Due to the oxygen demand of the wastewater (BOD) and the nature of most treatment wetlands (see section 3.3.1) oxygen supply is usually too low to support the nitrification process. The second problem conventional TWs face is being able to provide the correct conditions in the right order to support nitrification followed by denitrification. Nitrification requires aerobic conditions while denitrification can only take place if conditions are anoxic. This means total nitrogen (TN) removal cannot be achieved in a single-stage CW due to its inability to simultaneously provide both nitrification (aerobic) and denitrification (anaerobic) conditions (Zhi et al. 2015).

Because of the need for more effective removal of ammonia and TN during the 1990s vertical and horizontal flow CWs were combined to complement each other (hybrid and staged systems) to achieve higher treatment efficiency. However, the extra capital investment and complex operating conditions required by these hybrid systems create economic and technical barriers for increasing field application at a large scale (Zhi et al. 2015).

The problem of adequate removal of TN was the major cause of the emergence of a new generation of treatment wetlands in the late 1990's. These 4th generation treatment wetlands integrate hydraulic or aeration machinery into constructed wetlands to increase the supply of DO and therefore their treatment capabilities. 4th generation treatment wetlands, such as tidal flow wetlands and aerated wetlands, are a very promising approach for the future.

Figure 3.1 gives an overview of all different types of constructed treatment wetlands.

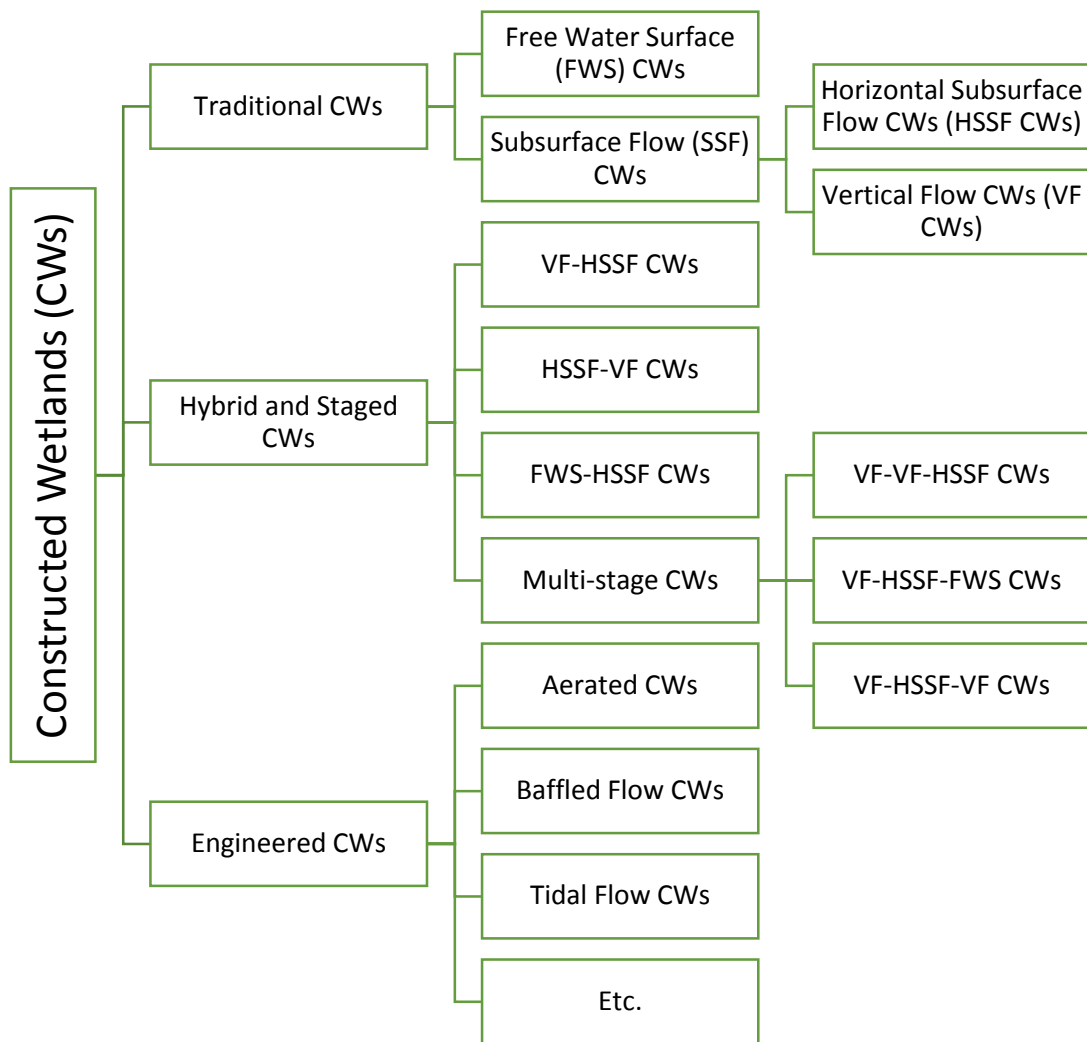

FIGURE 3.1: TYPES OF CONSTRUCTED WETLANDS

Note: CW, constructed wetland; FWS, free water surface; HSSF, horizontal sub-surface flow; and VF, vertical flow.

3.2. Tidal Flow Constructed Wetlands

Tidal flow artificial wetlands (TFAW) are a type of 4th generation (or intensified) wetland systems (see Figure 3.1) for biological wastewater treatment that are designed to copy the processes of natural tidal wetlands (<http://www.livingmachines.com> 2015). A TFAW operates by continually filling and draining the wetland cell with wastewater. This cycle of filling and draining introduces additional oxygen to the wetland cell. With this engineered CW vastly improved aeration and hence outstanding total nitrogen removal compared to traditional wetland systems is possible. (Behrends 1999)

Early research of tidal flow wetlands was done in the late 1990s (Sun et al. 1999) and TFAWs were defined by having a fill and drain cycle of less than a day. A tidal flow

wetland was created with different stages of wetland cells which were operated in series. The water that filled the first stage was drained to the next stage and so on. 5 stages were common at this early stage of research (Sun et al. 2006; Zhao, Sun & Allen 2004).

Around the same time Leslie L. Behrends was doing research for the Tennessee Valley Authority in the USA and filed a first patent for “Reciprocating Subsurface-Flow Constructed Wetlands for Improving Wastewater Treatment” (Behrends 1999). His type of tidal flow wetland differed in that it consisted of wetland cell pairs. Instead of filling and draining wastewater through the different stages of the wetland system one wetland cell was filled and the water reciprocated between the two cells that together formed a cell pair. This type of tidal flow system is known as a ReCip tidal flow system.

3.2.1. ReCip Tidal Flow System

As mentioned above L. Behrends’ research and his patents were the basis for a specific type of tidal flow wetland which was later used by Living Machines® and Sustainable Water™ for their decentralized wastewater treatment and re-use systems that are still being designed and implemented today.

This type of TFAW consists of at least two adjacent cells, however, in most designs the systems consist of more than two cells and these are usually designed to work together in series in sets of two (pairs). Within these cells the system utilizes plants, robust microbial fixed-film ecosystems and passive aeration (reciprocating flow) to treat the wastewater (Behrends & Lohan 2012). For a complete wastewater treatment system the TFAW wetland is combined with a pre-treatment and a final polishing unit to make the treated water fit for re-use. A process schematic of a complete treatment system by Living Machine® is shown in Figure 3.2.

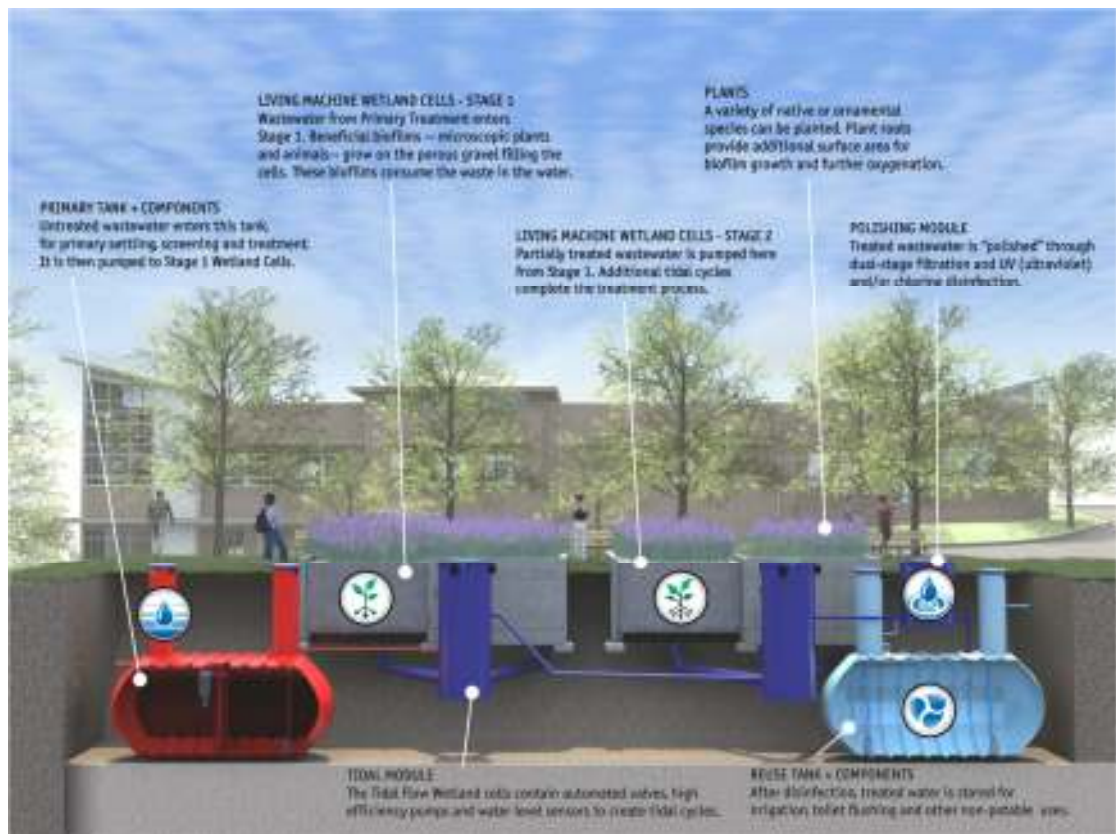

FIGURE 3.2: LIVING MACHINES® PROCESS SCHEMATIC
([HTTP://WWW.LIVINGMACHINES.COM](http://www.livingmachines.com) 2015)

Treatment advantages compared to conventional CWs occur because of the ability of the system to provide anaerobic, anoxic and aerobic environments within and between the cells via reciprocation. Water drained from one cell is stored in the contiguous cell, and vice-versa. This cycle of draining and filling of the wetland cells means that tidal flow wetlands provide perfect conditions for nitrification and denitrification which is essential for the process of total nitrogen removal. (<http://sustainablewater.com/recipe- reciprocating-wetlands/> 2015)

To date this type of TFAW has been used to treat and reuse wastewater at schools, universities, small communities, public buildings, large offices, campgrounds, resorts, military bases, industrial parks, airports and animal feeding operations (Behrends & Lohan 2012). They can be designed to be integrated into landscaping or built into a building or greenhouse (<http://www.livingmachines.com> 2015). This means they can be used where space is limited.

Like most other wastewater treatment systems ReCip TFAWs consist of different stages of water treatment. Firstly is primary treatment which is done in primary treatment tanks for coarse-solids and floating material removal. A flow equalisation

tank can either be separate or integrated with the primary treatment tank. The flow equalisation tank buffers periods of high and low flow.

Primary treatment is followed by the actual tidal wetland treatment cells. These can provide treatment to tertiary treatment standards. The tidal flow wetland cells are gravel-filled modules with underdrains. Each pair is connected via pipes and a pumping system. The tidal flow wetland cells can be set up in stages which means the first pair of treatment cells is followed by a second and so on, depending on wastewater needs. Common are two stages of wetland cells with each stage filled with different type of aggregate, the second stage usually filled with a smaller type aggregate to provide faster treatment.

The treatment wetland cells are followed by polishing modules that contain filters and disinfection components (UV and/or chlorine) for removal of pathogens.

The last step of the treatment system is the reuse tank and associated pumping components. Plants are added to the system to increase the removal of residual nutrients.

The whole system is fully automated and uses a remotely sensed control panel which operates all mechanical components. A summary of all common components can be seen in Figure 3.3 below.

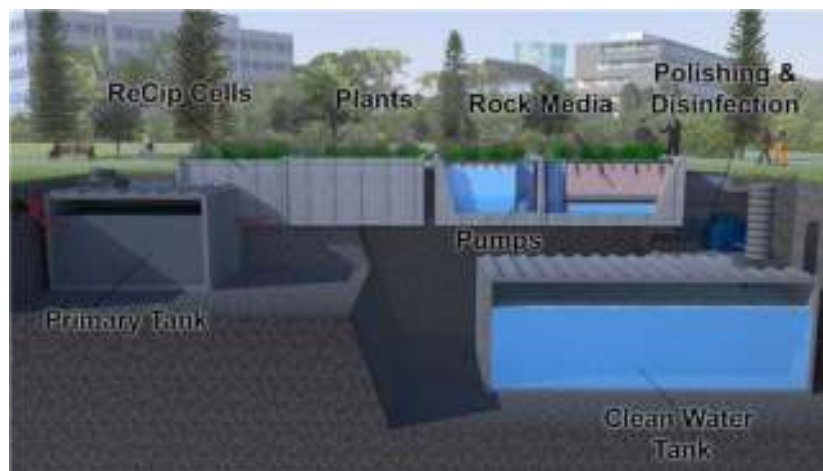

FIGURE 3.3: RECIP PROCESS SCHEMATIC ([HTTP://SUSTAINABLEWATER.COM/RECIP-RECIPROCATING-WETLANDS/](http://sustainablewater.com/recip-reciprocating-wetlands/) 2015)

3.2.2. Fill and Drain Tidal Flow Wetlands

Research on the original fill and drain tidal flow wetland continued. Various different operating strategies were investigated to improve treatment processes and to prevent clogging of the wetland cells. This included using different types of wetland aggregates (Austin 2006; Liu et al. 2014; Vohla et al. 2011; Zhao et al. 2011; Zhao, Sun & Allen 2004; Zhao, Zhao & Babatunde 2009). Trials of varying the number of stages of wetlands cells and the introduction of wetland cell resting periods to prevent clogging of the wetland media were carried out. In 2006 (Austin) investigated the CEC capacity of different wetland aggregates and the influence it would have on treatment performance especially nitrogen. He found that the CEC capacity of the wetland aggregate affected treatment performance significantly. A high CEC capacity achieved a higher treatment level due to the high ammonium-ion adsorption capacity of high CEC aggregates (more in section 3.5). A study by Liu (2014) confirmed this research.

In 2009 and 2011 (Zhao et al.) carried out research with alum sludge-based treatment wetlands. His results were promising, as he achieved good treatment performances for BOD, TSS and nitrogen removal as well as phosphorus. He was able to achieve comparable treatment results to other previous studies on a smaller area. The most important part of his study was the high removal rate he achieved for phosphorus. While these are very promising results, more long term studies are required to determine the service lifetime of this type substrate. The removal of phosphorus by adsorption has a finite capacity and the performance of the system is not expected to be able to be maintained over a long period of time (more in section 3.3.2).

3.3. Contaminants and Contaminant Removal in a TFAW

TFAW are usually designed to receive primary treated wastewater. During the primary treatment stage solids settle out of the wastewater and begin to degrade. The remaining (primary treated) wastewater is pumped to the tidal flow wetland cells.

3.3.1. Nitrogen

Nitrogen enters wastewater through various pathways. The most abundant contributor of nitrogen in typical municipal wastewater is urea (urine), others are food processing waste, chemical cleaning agents etc. High levels of nitrogen in natural waterways can

result in toxic conditions for wildlife, dissolved oxygen (DO) depletion and excessive algae growth, all harmful to local plant, animal and human populations. This is why the ability to remove TN during the wastewater treatment process is important.

The removal of nitrogen from wastewater is a complex process. It includes various forms of nitrogen, all important, especially in a treatment wetland as each form is necessary to keep the ecosystem balanced. For wastewater treatment, especially wastewater treatment using constructed wetlands, the most important forms of inorganic nitrogen are ammonium (NH_4^+), nitrite (NO_2^-) and nitrate (NO_3^-) and gaseous forms such as dinitrogen (N_2), nitrous oxide (N_2O), nitric oxide (NO_2 and N_2O_4) and ammonia (NH_3). Constant chemical processes transform the various forms of nitrogen from organic to inorganic and back from inorganic to organic. These constant transformations ensure the ecosystem functions successfully. (Vymazal 2007)

The removal of nitrogen from wastewater can be achieved by various processes. These include ammonia volatilisation, ammonification, plant and microbial uptake, adsorption, nitrification, denitrification, and anaerobic ammonia oxidation (ANAMMOX), among others. Table 1 summarises these processes.

TABLE 1: NITROGEN TRANSFORMATIONS IN WASTEWATER TREATMENT/CONSTRUCTED WETLANDS (VYMAZAL 2007)

Process	Transformation
Volatilization	ammonia-N (aq) \rightarrow ammonia-N (g)
Ammonification	organic-N \rightarrow ammonia-N
Nitrification	ammonia-N \rightarrow nitrite-N \rightarrow nitrate-N
Nitrate-ammonification	nitrate-N \rightarrow ammonia-N
Denitrification	nitrate-N \rightarrow nitrite-N \rightarrow gaseous N_2 , N_2O
N_2 Fixation	gaseous N_2 \rightarrow ammonia-N (organic-N)
Plant/microbial uptake (assimilation)	ammonia-, nitrite-, nitrate-N \rightarrow organic-N
Ammonia adsorption	
Organic nitrogen burial	
ANAMMOX (anaerobic ammonia oxidaton)	ammonia-N \rightarrow gaseous N_2

Most of these processes only convert nitrogen to its various forms (as shown in Table 1). Only a few of those processes ultimately remove total nitrogen. These include volatilization, denitrification, ANAMMOX, organic nitrogen burial, ammonia adsorption and plant/microbial uptake (Vymazal 2007). As this thesis concentrates on tidal flow wetlands which are a special type of vertical flow subsurface wetlands, the removal of nitrogen via volatilisation and organic nitrogen burial is irrelevant (Vymazal 2007). Biological nitrification coupled with denitrification is widely recognized as being one of the main factors contributing to total nitrogen removal in TFWs (Liu et al. 2014). A simplified nitrogen process diagram for a tidal flow wetland is shown in Figure 3.4.

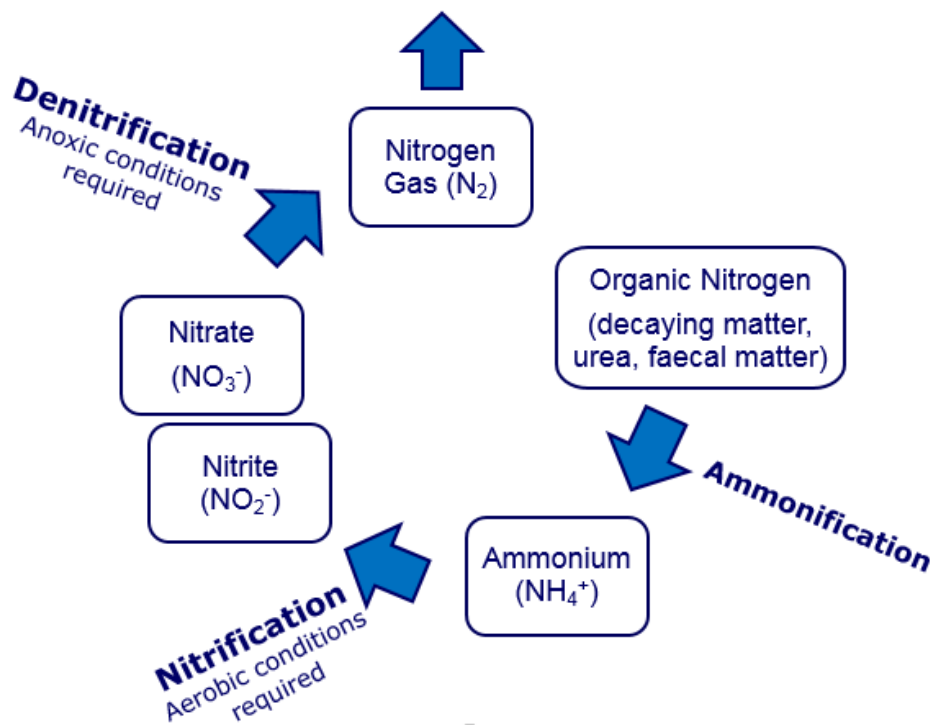
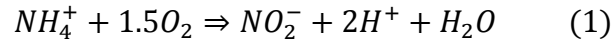

FIGURE 3.4: SIMPLIFIED NITROGEN REMOVAL STAGES

Nitrification reduces the concentration of ammonia nitrogen by converting ammonia nitrogen to oxidized nitrogen (nitrate). This is a two-step process. Both steps can proceed only in the presence of oxygen (aerobic conditions), therefore the actual nitrification rate can be controlled by the flux of dissolved oxygen into the system

(Kadlec & Wallace 2008). The chemical equations of the nitrification process are shown below.

EQUATION 1: OXIDATION OF AMMONIA TO NITRITE (VYMAZAL 2007)



EQUATION 2: OXIDATION OF NITRITE TO NITRATE (VYMAZAL 2007)

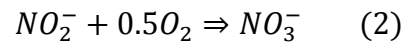

Nitrification provides nitrate for the following denitrification process (which ultimately removes nitrogen from the wastewater). This means the available nitrate from the nitrification process depends on the available oxygen in the systems. Hence nitrification is the limiting process for this nitrogen removal process (nitrification coupled with denitrification) and the availability of oxygen needs to be ensured to achieve high nitrogen removal rates (Vymazal 2007). In most traditional types of wetlands this rate of oxygen supply needed to achieve a high nitrification rate cannot be accomplished.

Denitrification is the process in which nitrate is converted into dinitrogen (nitrogen gas). Denitrification is carried out by facultative heterotrophs, organisms that can either use oxygen or nitrate as terminal electron acceptors. The chemical equation of the denitrification process is shown below.

EQUATION 3: CHEMICAL EQUATION DENITRIFICATION (VYMAZAL 2007)

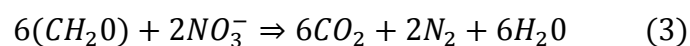

For denitrification to take place in a wetland the oxygen content in the water has to be very low (anoxic conditions). Only then do the facultative heterotroph bacteria choose nitrate over the oxygen as their electron acceptor. The biomass or other organic residues present in the wastewater are used as the carbon or electron source. (Kadlec & Wallace 2008).

When a TF wetland cell is filled with wastewater, ammonia ions in the water adsorb to the wetland media biofilms. The adsorption rate depends on the cation exchange capacity (CEC) of the aggregate used (Austin 2006). During the subsequent drain cycle of the wetland cell the thin water films surrounding the dewatered substrate and attached biofilms are exposed to atmospheric oxygen, creating aerobic conditions. This exposure of the attached ammonia ions to aerobic conditions causes rapid nitrification (formation of nitrate) and respiration. During the next flood stage the wetland media is submerged again which causes the aerobic biofilm to turn anoxic, therefore providing ideal conditions for denitrification that may ultimately produce molecular nitrogen (N_2). This process is shown in the below figure.

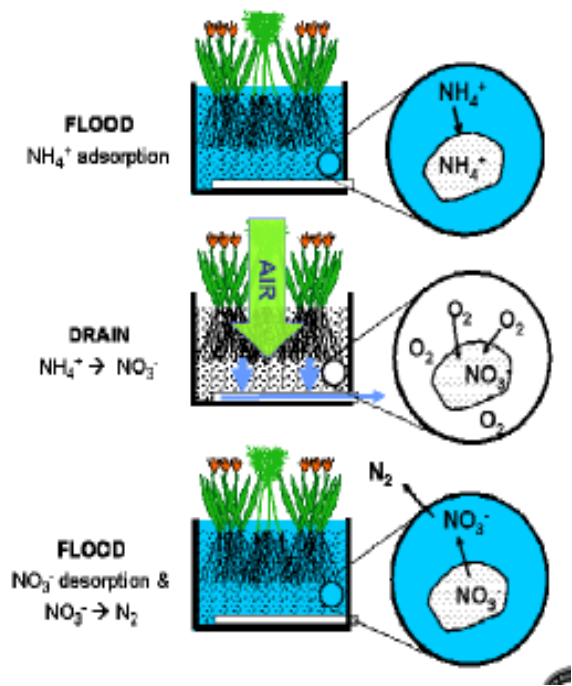

FIGURE 3.5: NITROGEN REMOVAL IN A TIDAL FLOW WETLAND CELL (AUSTIN 2003)

This process of filling and draining will be repeated depending on wastewater needs (target treatment level, influent wastewater concentration) usually as often as six to twelve times a day. (Austin, Lohan & Verson 2003).

3.3.2. Phosphorus

Phosphorus is an essential nutrient for humans, animals and plants and therefore forms part of a human diet. Similar to nitrogen, it enters our wastewater from various sources. The main sources of phosphorus in municipal wastewater are human excreta and chemical cleaning products. Water bodies are naturally low in phosphorus, but human activities are causing larger amounts of phosphorus to enter freshwater systems. Unnaturally large amounts of phosphorus create excessive algae growth which eventually causes the depletion of DO in the water. This is why phosphorus removal to a level that is acceptable for natural wastewaters is important.

The removal of phosphorus in CWs usually involves adsorption of filter media and the precipitation of bound metal salt like Fe, Al and Ca. Many studies have been undertaken to investigate different types of wetland substrates and their influence on phosphorus removal. Traditional wetland substrates like gravel and crushed rock provide limited capacity for sorption and precipitation, however some studies have demonstrated successful removal using different types of substrates like Alum Sludge and LECA (light weigh clay aggregates) (Zhao et al. 2011). It is important to note, however that these processes are saturable. This means even though these studies have demonstrated successful phosphorus removal initially, high removal rates are often not sustained in the long term. (Vymazal 2007) Further research is needed to investigate high phosphorus removal rates for the long term.

3.3.3. Suspended Solids

Suspended Solids (SS) are removed from the wastewater by sedimentation and filtration when the water flows through the wetland cell. SSs are believed to be a main contributor to wetland cell clogging. Sufficient pre-treatment, allowing the removal of larger amounts of SS can prevent this. Studies on different types of wetland aggregates have been undertaken to see the affects these can have on wetland cell clogging due to SSs (Zhao, Sun & Allen 2004). These have found that anti-sized aggregates could have a positive effect on SS removal in tidal flow wetlands (Zhao, Sun & Allen 2004).

3.3.4. Biological Oxygen Demand

Biological Oxygen Demand (BOD) is a widely used parameter to describe the organic pollution in (waste-) water. BOD describes how much dissolved oxygen (DO) is needed by microorganisms to oxidise organic matter. This makes it a tool that measures organic matter pollution in wastewater. BOD does not include the dissolved oxygen needed for the nitrification process (see section 3.3.1).

Because DO is depleted when wastewater is high in organic matter insufficient treatment and discharge of wastewater can quickly lead to oxygen depletion in water bodies. High BOD concentrations during wastewater treatment also leads to oxygen competition which results in very low nitrification rates.

Studies have shown that TFWs, as opposed to conventional CWs, can transfer enough oxygen from the atmosphere to the interface of the biofilm during the drained phase to support oxidation of organic matter as well as nitrification even for high strength wastewater (Wu et al. 2011). While in theory high organic loadings are able to be oxidised in a TFW, some experiments have shown major problems with excessive growth of biofilm on the wetland aggregate which eventually leads to clogging of the wetland cell (see section 3.4). Therefore, even though in theory, a tidal flow wetland can supply enough oxygen to support high BOD and ammonia loadings, BOD loadings have to be limited to prevent clogging.

3.4. Clogging

The term “clogging” is used in subsurface flow CW’s and describes the blockage of the wetland aggregate that can occur during operation of the wetland cell. Clogging is a major operational issue that compromises the treatment performance and therefore is to be avoided by any means. Issues that arise from wetland cell clogging are: decreased treatment performance, hydraulic malfunction (ponding of wastewater) and bypassing of untreated wastewater. Clogging can shorten the lifetime of the system dramatically. (Knowles et al. 2011)

Clogging can be caused by different processes. It is usually caused by a combination of solids entrapment and biofilm growth as well as other minor factors such as vegetation growth and chemical effects (Knowles et al. 2011). These are all factors that can be influenced by design and operational factors, so there is a need to develop

design strategies for different types of wetlands to minimise or eliminate wetland clogging altogether.

Such design strategies should include maximum influent distribution, intermittent dosing, wetland cell resting periods, and sufficient pre-treatment (especially for TSS) (Knowles et al. 2011).

3.5. Aggregate

Conventional CW aggregates usually consist of locally available material such as crushed granite and basalt. Aggregate can often be the most expensive part of a subsurface CW. Studies have been undertaken (Austin 2006) to research the treatment ability of different types of aggregate to determine if treatment ability of better performing wetland aggregates are worth the additional capital cost. Transportation costs can add a significant amount to the total cost of aggregate especially in remote locations with limited choices of locally available aggregates.

It was found that the CEC capacity of an aggregate can have a major influence on the treatment performance of a wetland cell especially for nitrogen removal (Austin 2006). Using an aggregate with a high CEC capacity means that wetland cells can achieve the same treatment performance on a smaller volume. This reduces the amount of aggregate needed and therefore lowers costs.

3.6. Summary

Over the last century, wastewater treatment has developed from basic removal of BOD and TSS to advanced treatment technologies, such as activated sludge systems. These systems can achieve high treatment standards for BOD, TSS as well as nutrients, pathogens and heavy metals. However, these advances come with high energy use. Rising costs of fossil fuels and concerns about sustainability and environmental protection have led to intense research into low energy natural treatment systems such as CWs. It was soon clear that traditional (passive) CWs struggle to achieve those required high treatment standards while still being economically feasible. The review of current and past research shows that engineered CWs, such as TFWs, are a successful approach in closing the gap between highly engineered, high energy

wastewater treatment systems and natural low or zero energy treatment systems such as CWs.

Early research into TFWs concentrated on nitrogen removal. Using TFWs is a perfect approach to TN removal due to the ability to provide enough oxygen to support the removal of organic matter as well as oxidation of ammonia nitrogen. TFWs are also able to provide the right conditions for nitrification, the process of ammonia oxidation, as well as denitrification. This means TFWs are able to reduce TN concentration considerably.

More recent research has focused on phosphorus removal. Phosphorus removal has proven to be low in conventional CWs. Studies using substrates such as alum sludge have had successful outcomes, but long-term studies still need to be undertaken, to see if this level of phosphorus removal is able to be maintained in the long term.

Tidal flow wetlands have successfully been used as part of a stand-alone decentralised wastewater treatment and re-use system such as the Living Machine© and Sustainable Water™ systems. These systems make use of the compact size and advanced treatment performance of the tidal flow wetland, by incorporating them into buildings and outside areas of public and outdoor spaces. The complete treatment system achieves high treatment levels. This means the treated wastewater can be re-used on site and hence reduce potable water usage considerably.

The outstanding nitrogen removal capabilities make tidal flow wetlands an interesting option for tertiary treatment alone after secondary treatment was undertaken by an activated sludge system or similar. Another option for tidal flow wetlands is the complete wastewater treatment in remote locations or developing countries that don't have access to highly engineered centralised systems such as activated sludge. Chapter 3 of this study focuses on the comparison of TFWs with other treatment systems. This section will give more insight into the way TFWs could replace conventional treatment wetlands for wastewater treatment as well as activated sludge systems for tertiary treatment.

CHAPTER 4 - CHARACTERIZATION, ANALYSIS AND COMPARISON OF CONSTRUCTED TREATMENT WETLANDS

4.1. Types of passive Constructed Wetlands

Conventional (passive) constructed wetlands (CW) for wastewater treatment can be divided into three main types - free water surface (FWS) wetlands, horizontal sub-surface flow (HSSF) wetlands and vertical sub-surface flow (VF) wetlands. Each of these has variations in layout, soil media used and flow patterns. Different types of passive wetlands can be combined to create hybrid or staged systems that utilise the combined advantages of individual systems.

4.1.1. Free Water Surface Wetlands

Free water surface (FWS) CWs generally consist of large shallow areas of open water (ponds) lined with an impermeable barrier to prevent seepage and control flow. Submerged media like rocks, gravel and soil supports the roots of the macrophyte vegetation which can consist of floating, submerged and/or emergent type plants. The wastewater treatment processes occurring are sedimentation, filtration, oxidation, reduction, adsorption and precipitation. A typical FWS wetland layout is shown below:

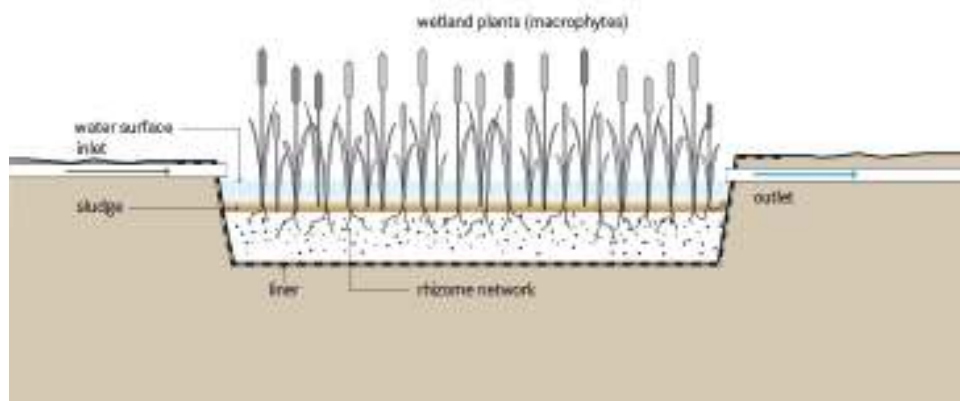

FIGURE 4.1: SCHEMATIC FWS CONSTRUCTED WETLAND (TILLEY ET AL. 2014)

FWS wetlands are constructed to mimic natural occurring wetlands and hence attract a wide variety of wildlife such as insects, fish, mammals, amphibians, reptiles and molluscs (Kadlec & Wallace 2008).

FWS wetlands are efficient in removing BOD by microbial degradation. The removal of SSs is very efficient. Due to the slow flow, the open water surface and the vegetation SSs can either be removed by settling or by filtration through the vegetation. Nitrogen removal in FWS wetlands can be problematic. As mentioned in section 3.3.1. Nitrogen removal is a two-step process (nitrification followed by denitrification) and FWS wetlands are not able to provide ideal conditions for the complete process. FWS wetlands are low in oxygen and cannot provide enough oxygen for the nitrification process. They do, however, provide suitable conditions for denitrification. Phosphorus removal in FWS is low. The wastewater in FWS wetlands has limited contact with the soil which means the conditions needed for phosphorus removal by adsorption or precipitation are not present. Some phosphorus can be taken up by plants but this is only a temporary storage unless these plants are harvested before decaying and reintroducing the phosphorus back to the water. (Vymazal 2010)

4.1.2. Horizontal Sub-surface Flow Wetlands

HSSF CWs consist of filter media such as a gravel or soil bed planted with emergent wetland vegetation, an impermeable liner to prevent infiltrating and inlet and outlet piping that keeps the water level under control. The water level is kept below the surface of the gravel/soil media at all times. The pre-treated wastewater flows horizontally from the water inlet through the wetland media to the outlet pipe. There is no exposed open water surface, hence the water has to flow through the gravel in and around the roots. A typical schematic is shown below.

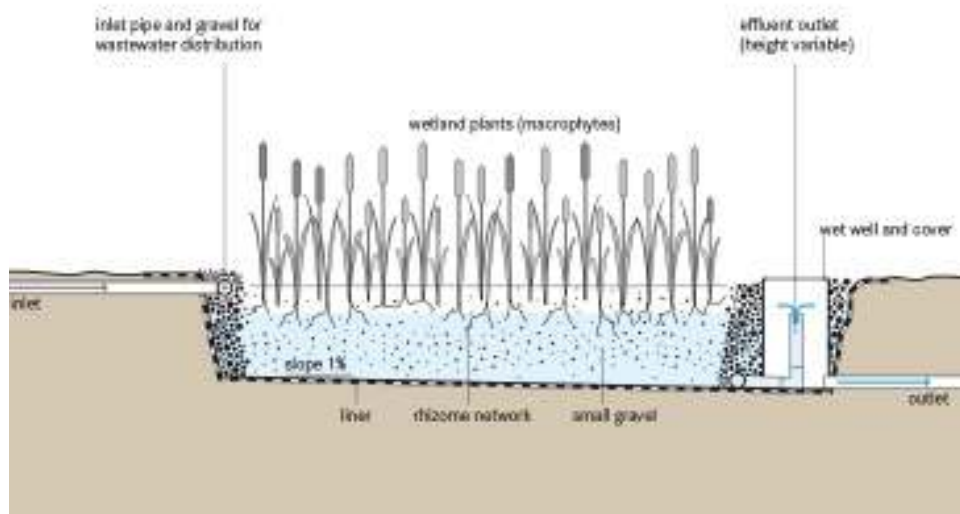

FIGURE 4.2: SCHEMATIC HSSF CONSTRUCTED WETLAND (TILLEY ET AL. 2014)

When the wastewater flows through the wetland aggregate physical, chemical and biological processes take place. Filtration and sedimentation efficiently remove SSs while organic compounds are removed by microbial degradation. A HSSF wetland predominantly provides anaerobic/anoxic conditions where the major removal mechanisms for nitrogen again is denitrification. This means the removal of ammonia nitrogen is very limited due to the lack of oxygen throughout the wetland cell. Phosphorus removal in HSSF wetlands is low unless a suitable wetland media is used. (Vymazal 2010)

4.1.3. Vertical Sub-surface Flow Wetlands

VF CWs can be used for secondary or tertiary treatment of black- or greywater. Wastewater usually undergoes primary settling treatment before entering the system. There are several variations of VF wetlands.

One of the main ones uses *intermittent downflow* and is often used in Europe. The surface of the VF CW is loaded in pulses at the top, the water then flows vertically through the filter media and the treated water is collected at the bottom by drainage pipes. This process allows oxygen to diffuse through the porous filter media during the unsaturated stage.

Another type of VFCW uses *unsaturated downflow*. Wastewater is distributed across the tops of the porous wetland media and slowly trickles through in unsaturated flow, where it comes in contact with microorganisms attached to the filter media. This type of system can be set up as single-pass mode or the water can be recirculated multiple times.

For all above systems the porous media used acts as a filter to remove solids, provides a surface that bacteria can attach to and also provides a base for the vegetation. This means VF wetlands are efficient in BOD and SS removal. The vegetation maintains permeability of the filter media and also provides a habitat for microorganisms. It also transfers small amounts of oxygen to the roots zone which allows aerobic bacteria to colonize the area and degrade organics. (Kadlec & Wallace 2008)

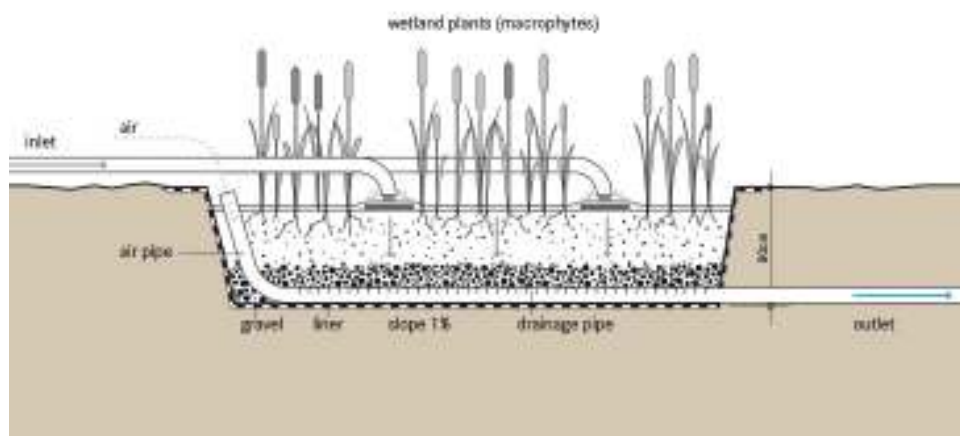

FIGURE 4.3: SCHEMATIC VF CONSTRUCTED WETLAND (TILLEY ET AL. 2014)

Due to the unsaturated flow and the intermittent loading operation of VF wetlands oxygen is diffused through the wetland bed which creates aerobic conditions within

the wetland cell. This means VF wetlands can provide good condition for nitrification. However the oxygen transfer capacity of a VF CW often still fails to fully meet the microbial need for carrying out organic matter oxidation and nitrification. VF CWs cannot provide the right conditions for denitrification and hence TN removal in a VF CW is not possible. Again phosphorus removal is low unless a high sorption capacity aggregate is used. (Vymazal 2010)

4.1.1. Hybrid Constructed Wetlands

When different types of CWs are combined to work together in a system they are referred to as a hybrid system. Hybrid systems were developed to combine the advantages of single systems in one system and therefore improve treatment efficiency. This is particularly important for TN removal. Single CW on their own cannot provide conditions for both nitrification and denitrification at the same time, but hybrid systems can. Hybrid systems often consist of a VF and a HSSF CW, but various combinations, including recirculating of the water, are possible.

4.1.2. The French System Vertical Flow Constructed Wetland

The so called “French System” is a specific type of VF CW that has successfully been implemented mainly in France. The current design of a French System is a two staged vertical flow CW system with each of its stages further divided into separate parallel filters. Stage one is divided into 3 parallel filters and stage 2 divided into 2 parallel filters. This means there are three independent wetland filter bed in stage 1 and two in stage 2. Each filter bed in stage one is loaded for 3-4 days while the other two filter beds are being rested. This allows the filters in stage 1 to rest for twice as long as the operation time. In stage 2 the two filter beds are used alternately, which means equal time for resting and operation. The alternative operation and resulting wetland filter resting periods are fundamental in controlling the growth of the attached biofilm on the wetland aggregate as described in section 3.4. (Molle et al. 2005) Figure 4.4 shows the layout of a French system CW.

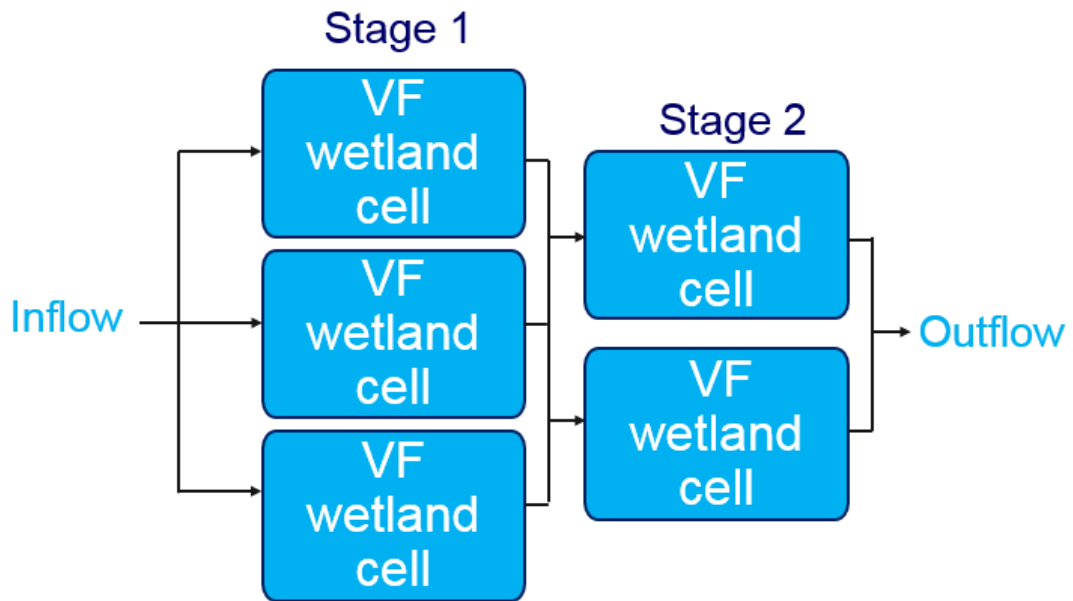

FIGURE 4.4: FRENCH SYSTEM TREATMENT WETLAND LAYOUT

The first stage of this type of VF CW is designed to mainly reduce the TSS and BOD load in the wastewater. During operation in the second stage of the wetland system the treatment process is completed and most of the nitrification process is carried out. Within the filter bed aerobic conditions are maintained. This is achieved by batch feeding of the wetland filters. With this setup near complete nitrification can be achieved, but denitrification is very low. (Molle et al. 2005).

4.2. Aerated Artificial Wetlands

Like tidal flow wetlands, aerated wetlands are a type of engineered treatment wetland. In aerated wetlands additional oxygen is introduced to the wetland cell by injecting air into the wetland bed via an air pump (Wallace et al. 2006). This introduction of additional oxygen greatly increases the nitrification rate of the wetland. However even though aeration leads to a reduction of ammonium nitrogen TN nitrogen is limited due to the lack of anaerobic conditions required for denitrification. The costs of continuous aeration can also be problematic (Wu et al. 2014).

4.3. Comparison of Alternative Treatment Systems to Tidal Flow CWs

4.3.1. Comparison of Treatment Wetlands

A site by site comparison of all different types of CWs is almost impossible as there are too many factors that influence results in different studies (e.g. climate/temperature, influent loads, variations in operation, weather pattern etc.). Various studies have been carried out, but each one usually focuses on the comparison of a couple of characteristics only and also includes only a few different wastewater systems at a time. Comparisons of different CWs can have different results in different studies, especially when climate or the weather pattern is different.

In 2009 a research facility was established in Langenreichenbach/Germany (NivalaHeadley, et al. 2013) which aimed to overcome these problems and investigated different types of advanced subsurface flow treatment wetland designs in a side by side comparison. Included in this comparison were 15 individual pilot scale versions of different wetland designs, these included planted and unplanted versions of passive and intensified wetlands systems. A summary of all included wetland systems is shown in Table 2. All systems were loaded with the same type municipal wastewater. Prior to entering the wetland systems the wastewater underwent primary treatment in a sedimentation tank.

TABLE 2: DESIGN AND OPERATIONAL DETAILS ON THE 15 TREATMENT SYSTEMS AT LANGENREICHENBACH, GERMANY (NIVALA WALLACE, ET AL. 2013)

System Abbreviation ^a	System Type	Effective depth ^b (cm)	Saturation Status	Main Media	Surface Area (m ²)	Hydraulic Loading Rate (L/m ² -d)
Horizontal Flow (HF)						
H25, H25p	HF	25	Saturated	8 – 16 mm gravel	5.64	18
H50, H50p	HF	50	Saturated	8 – 16 mm gravel	5.64	36
Vertical Flow (VF)						
VS1, VS1p ^c	VF	85	Unsaturated	1 – 3 mm sand	6.20	95
VS2, VS2p ^d	VF	85	Unsaturated	1 – 3 mm sand	6.20	95
VG, VGp	VF	85	Unsaturated	4 – 8 mm gravel	6.20	95
Intensified						
VA, VAp	VF + Aeration	85	Saturated	8 – 16 mm gravel	6.20	95
HA, HAp	HF + Aeration	100	Saturated	8 – 16 mm gravel	5.64	130
R	Reciprocating	95	Alternating	8 – 16 mm gravel	13.2	160

^a Systems planted with *Phragmites australis* are denoted with “p” in the system abbreviation.

^b Effective depth refers to the depth of the media involved in treatment. Depth of media not involved in treatment, (such as the fill above distribution shields in a vertical flow bed, or the layer of dry gravel in a saturated bed) was not considered.

^c Systems were dosed once every hour.

^d Systems were dosed once every two hours.

The study found that the intensified wetland systems (aerated and tidal flow) easily outperformed the passive systems in contaminant removal especially in the removal of ammonium-N. Even though hydraulic loading rates were much higher than for the passive systems the intensified systems still performed better and achieved low effluent concentrations. The reciprocating (tidal flow, R in table) wetland system had the highest removal rates for BOD₅, TOC and TN, the horizontal system with aeration had the highest rates for NH₄-N degradation and E. Coli removal (Nivala et al. 2012). The wetlands used in the study were quite specific. While results give a general idea of how different wetlands behave and compare, it is difficult to get exact numbers for removal rates and required areas, because the same wetland can perform differently depending on location, climate and wastewater concentration.

Table 2 gives a general overview of different types of wetlands, their requirements and removal capabilities.

TABLE 3: COMPARISON OF DIFFERENT TYPES OF CWS

	BOD removal	SS removal	Nitrification	Denitrification	Phosphorus removal	Land requirement	Energy requirement
FWS CW	high	high	low	medium	low	very large	zero
HSSF CW	high	high	very low	high	low	large	zero
VF CW	high	high	high	very low	low	medium to large	low or zero if loaded by a siphon
Hybrid CW	high	high	high	high	low	very large	low
Tidal Flow CW	high	high	very high	high	low	small	medium to low
Aerated CW	very high	high	very high	low	low	small to medium	medium

4.3.2. Comparison to Conventional Wastewater Treatment Systems

A study undertaken by Austin and Nivala (2009) investigates the energy requirements of three different constructed wetland systems compared to a traditional centralised mechanical activated-sludge treatment system. The engineered wetland systems included in this study were a two-cell aerated subsurface flow wetlands, a six-cell tidal flow wetlands and a two-cell pulse fed wetland (Figure 4.5).

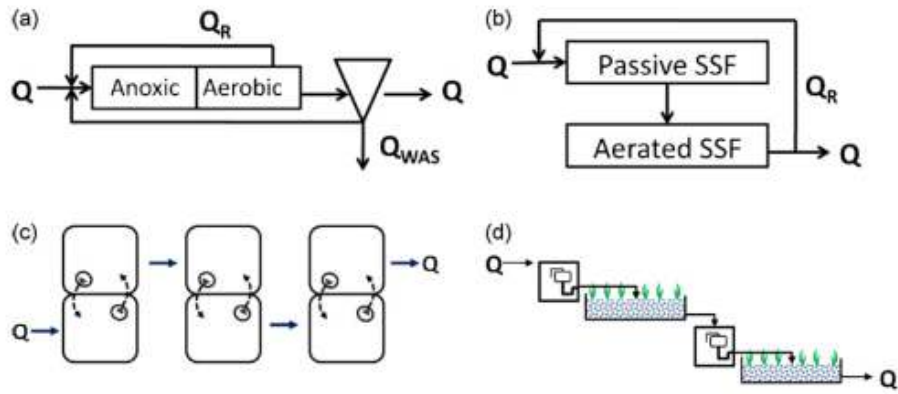

FIGURE 4.5: SYSTEM SCHEMATICS (AUSTIN & NIVALA 2009)

- (a) MLE: activated sludge with pre-anoxic denitrification from nitrified process recycle
- (b) Aerated wetland: organic carbon removal in passive first-stage horizontal SSF cell, with pre-anoxic denitrification from nitrifying (aerated) second-stage horizontal SSF cell
- (c) Tidal flow wetland: three paired cells with reciprocating pumped flow in each cell pair and overflow drain to next pair in series. The first stage rotates three paired cells in parallel to allow resting, but not pictured for simplicity
- (d) Pulse-fed wetland with siphon-dosed cells

Energy requirements were calculated based on the same hypothetical domestic wastewater, discharge target and daily flow rate for all technologies (Austin & Nivala 2009).

The study found that the energy requirement of the wetlands is significantly lower than the energy requirement of the activated sludge system despite all theoretical factors being the same for the calculations used. Tidal flow wetlands used less than 25% of the energy of an activated sludge treatment system in this design exercise and only half of the energy a equivalent aerated wetland would use. Figure 4.6 summarises these results.

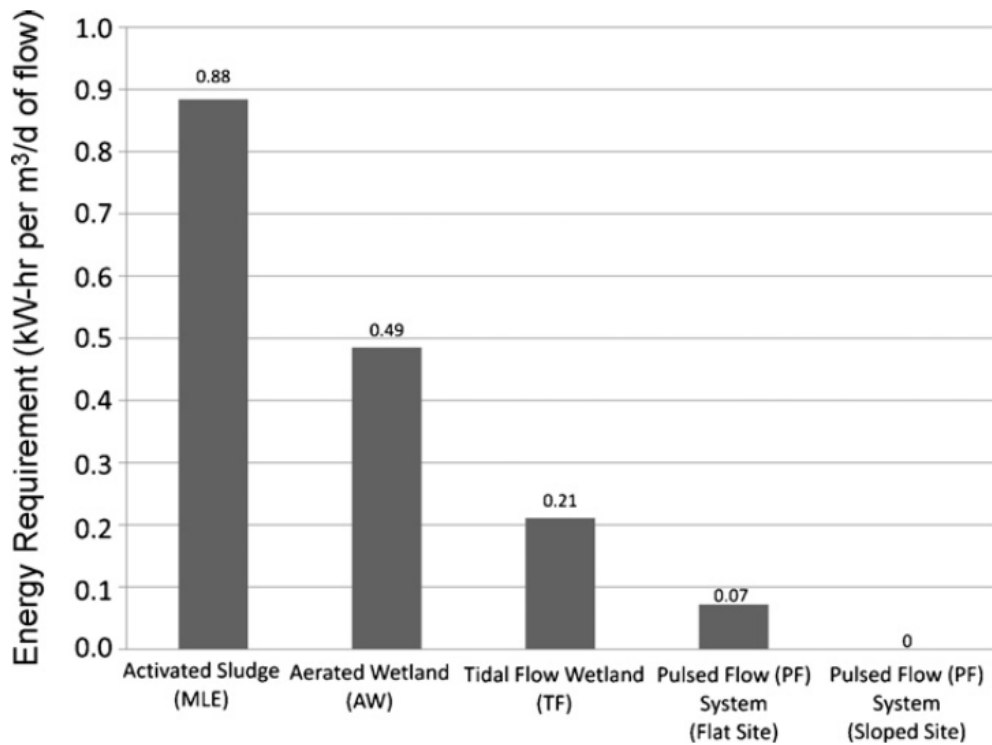

FIGURE 4.6: SUMMARY OF PROCESS ENERGY REQUIREMENTS (AUSTIN & NIVALA 2009)

4.4. Summary

This section has demonstrated some of the characteristics of different wastewater treatment options that are direct competition to TFWs. It has shown that unless conventional CWs are used in a hybrid or staged system, they are not able to achieve the treatment standards necessary for advanced wastewater treatment. The main reason for this is the inability to provide the right conditions needed for complete nitrogen removal.

Therefore, out of the chosen systems only aerated wetlands, hybrid/staged wetlands, and activated sludge systems are able to provide the same treatment level as a TFW.

The comparison of the remaining types of treatment systems (activated sludge, aerated wetlands, TFWs, and hybrid/staged CWs) shows that the wastewater treatment process is basically a compromise between land size requirement and energy use. A chart available on (<http://www.livingmachines.com> 2015) supports this (Figure 4.7).

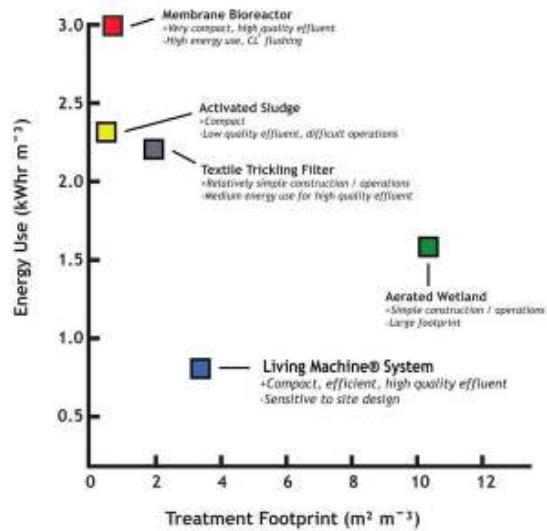

FIGURE 4.7: SIZE VS. ENERGY CONSUMPTION ON-SITE TREATMENT SYSTEMS (HTTP://WWW.LIVINGMACHINES.COM 2015)

The simplicity and low energy use of tidal flow wetlands makes them an ideal option for remote locations and underdeveloped countries where highly engineered systems such as activated sludge are not applicable due to their high energy demand and complicated operation and maintenance. Hybrid/staged systems are another option for remote and underdeveloped areas but can be impractical due to the land requirement of such systems. Tidal flow wetlands can be built out of locally available materials. Tidal operation can be maintained by simple pumps that are available even to remote and less developed areas. TFWs are simple to operate and only need minor maintenance.

In densely populated areas, highly engineered wastewater treatment systems such as activated sludge systems, are often the only option. The energy consumption of those systems could be reduced dramatically if combined with a TFW for nitrogen removal.

The next section shows in more detail how TFWs compare to a conventional (no energy) CWs for a specific wastewater situation.

CHAPTER 5 - COMPARISON OF A TIDAL FLOW WETLAND AND A PASSIVE (VF) WETLAND WHEN APPLIED TO WASTEWATER TREATMENT FOR A SMALL RESIDENTIAL DEVELOPMENT

5.1. Introduction

The purpose of this study is to explore in more detail the advantages and possibilities of TFWs as a sustainable treatment option compared with a conventional passive CW. For this, a comparison between a TFW and a conventional passive VF wetland was developed. The study is based on a hypothetical wastewater treatment situation of a small residential development or village. Both systems were exposed to the same wastewater situation and required wetland size and energy use was determined.

The small development chosen for this study is residential including about 25 houses. For this exercise 4 people per house on average are assumed, with a water usage of 200L per person per day. This means the designed wetlands will treat wastewater for 100 PE (person equivalent) and a wastewater flow of 20,000 L/d (20 kL/d). These are all hypothetical values for the purpose of this study.

5.2. Wastewater Flow and Strength

It is assumed that all wastewater undergoes primary treatment in a septic tank before entering further treatment. This assumption is made for both of the chosen wastewater treatment systems of this study. Table 4 shows the typical composition of municipal wastewater and percent removals at various levels of treatment (Kadlec 1995). Only constituents important to this study are shown.

TABLE 4: TYPICAL COMPOSITION OF MUNICIPAL WASTEWATER AND PERCENT REMOVAL AT VARIOUS LEVELS OF TREATMENT (KADLEC 1995)

Constituent	Raw Wastewater (mg/L)		Percent Removal		Secondary Effluent (mg/L)	
	Typical	Range	Primary	Secondary	Typical	Range
BOD₅	220	110-400	0-45	65-95	20	10-45
TSS	220	100-350	0-65	60-90	30	15-60
NH₄-N	25	12-50	0-20	8-15	10	<1-20
NO₃+NO₂-N	0	0	-	-	6	<1-20
Org-N	15	8-35	0-20	15-50	4	2-6
TKN	40	20-85	0-20	20-60	14	10-20
Total N	40	20-85	5-10	10-20	20	10-30
Total P	8	6-20	0-30	10-20	6	4-8

As the table shows, wastewater characteristics can vary widely. For the purpose of this study the following raw wastewater composition and primary effluent levels were chosen:

BOD₅:	220 mg/L	after primary treatment:	150 mg/L
TSS:	220 mg/L		110 mg/L
NH₄-N:	25 mg/L		22 mg/L
Org-N:	15 mg/L		13 mg/L
TKN:	40 mg/L		35 mg/L
Total N:	40 mg/L		37 mg/L
Total P:	8 mg/L		7 mg/L

5.3. Treatment Target

The target effluent concentration used for this exercise is:

BOD: 10 mg/L

TSS: 10 mg/L

Total nitrogen: 10 mg/L

Phosphorous: 5 mg/L

This treatment target is in the range of tertiary treatment.

5.4. ReCip Tidal Flow Wetland

For the comparison in this study a ReCip tidal flow wetland was chosen. This means the tidal flow wetland will be designed in wetland cell pairs. A flow diagram for this preliminary design is shown in Figure 5.1.

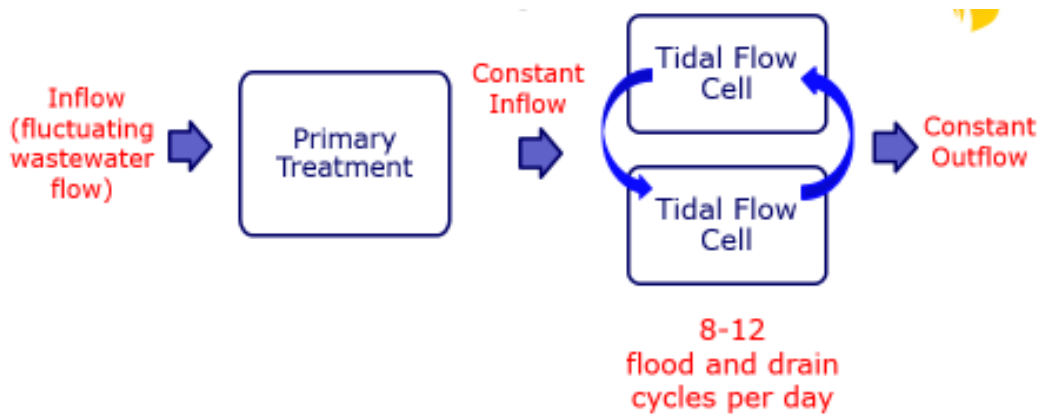

FIGURE 5.1: FLOW DIAGRAM TIDAL FLOW WETLAND

5.4.1. Preliminary Sizing

Preliminary sizing of the tidal flow wetland is based on the BOD and nitrogen load of the wastewater. The total size of the wetland is determined by choosing whichever parameter requires the larger area or volume. This depends on the concentration of each contaminant.

The daily wastewater flow is 20,000 L/day which is equivalent to 834 L/h

2 hours should be allowed to complete each flood and drain cycle. Hence a maximum of 12 cycles per day are possible.

Screening for BOD:

The total daily BOD load was determined:

$$\text{BOD load} = 20,000 \text{ L/d} * 150 \text{ mg/L} = 3000 \text{ g/d}$$

To prevent clogging of the wetland cell the BOD load should be limited to 50 g BOD/m² (D. Austin 2015, pers. comm., 15th Aug). Many laboratory studies suggest a much higher BOD loading rate, but wastewater in laboratory based studies are often artificially prepared, which means they do not contain any suspended solids. Suspended solids trapping is one of the main reasons for the clogging process (Li, Wu & Dong 2015), hence for the purpose of this study a much lower BOD loading rate per square meter was chosen. From that the minimum required surface area can be calculated.

$$\text{Minimum surface area} = (3000 \text{ g/d}) / (50 \text{ g/m}^2/\text{d}) = 60 \text{ m}^2.$$

60 m² is the area required for one wetland cell. The chosen ReCip tidal flow wetland requires a second wetland cell, as it is designed to operate in cell pairs. This means a second wetland cell of the same size is required. Therefore the total minimum size needed to remove the required amount of BOD is 120 m².

The depth of the wetland cells is assumed to be 0.5 m, with this the wetland cell volume can be calculated.

$$\text{Choose a depth of } 0.5 \text{ m} \rightarrow \text{minimum volume per cell} = 30 \text{ m}^3.$$

This equals a total volume of 60 m³.

Screening for TKN:

To size the wetland cells for total nitrogen removal the nitrogen load in each fill and drain cycle has to be determined. The ammonium adsorption rate of the wetland cell depends on the type of aggregate chosen. For the purpose of this comparison an aggregate with a low adsorption rate is chosen. Choosing an aggregate with a higher adsorption rate (higher CEC) will result in a higher nitrification rate without changing the wetland cell size (Austin 2006). Details about the CEC of wetland aggregate can be found in section 3.5.

The nitrogen load during one cycle is determined from the nitrogen concentration of the wastewater and the length of each cycle (2h).

$$\text{TKN load} = 35 \text{ mg/L} \times 834 \text{ L/h} \approx 30 \text{ g/h}$$

For a 2-hour cycle the load is 60 g/cycle.

The aggregate should be able to adsorb 2-4 times the TKN -load in each cycle. Hence the CEC of the aggregate and the size of the wetland cell should be chosen accordingly. This means that the aggregate in each of the two wetland cells has to be able to absorb $4 \times 60 \text{ g} = 240 \text{ g}$ of TKN.

Assume a low CEC of the aggregate of 20 g/m^3

$$\text{Minimum volume of the cell} = 240 \text{ g} / 20 \text{ g/m}^3 = 12 \text{ m}^3$$

Therefore when choosing an aggregate with a CEC of at least 20 g/m^3 a minimum cell size of 12 m^3 is required to remove all of the TKN during nitrification. This means complete nitrification is possible.

After this the wetland cell has to be checked to see if it is large enough to allow for all the wastewater to be treated during the 12 cycles per day. Therefore the porosity of the aggregate was assumed to be 40%.

Assume a porosity of the aggregate to be 40%:

$$\text{Pore volume of the cell} = 12 \text{ m}^3 \times 0.4 = 4.8 \text{ m}^3$$

$$4.8 \text{ m}^3 \times 12 \text{ cycles per day} = 57600 \text{ L/d.}$$

Therefore the wetland cell is big enough to treat 57600 L/d of water volume over 12 cycles, sufficient for the design flow of 20,000 m^3 .

Final wetland size:

When comparing the BOD (minimum area per cell: 60 m²) and TKN (minimum volume per cell: 12 m³ at AEC of 20 g/m³) it was found the BOD loading limited the design sizing. Therefore the minimum area of each of the two wetland cells was chosen to be 60 m². With a depth of 0.5 m the required volume of each cell is 30 m³.

To prevent clogging of the substrate by excess biofilm growth it is recommended that resting periods of the wetlands cells be allowed. In this instance the wetland cell is divided into 2 separate parallel operating systems. This means only one of the parallel systems is operated at any one time while the other wetland beds are rested.

With the wetland cells divided into two systems each operating cell halved in size, which is 30 m² and with a depth of 0.5 m the volume is 15 m³. This is still big enough to ensure full nitrification (minimum volume required 12 m³)

Again a porosity of 40% for the aggregate is assumed, so the pore volume of each cell is 6 m³ = 6,000 L. This means the forward flow of the wastewater (20,000 L) fills and drains the wetland cell less than 4 times. To recharge the CEC of the wetland cell aggregate a recycle flow is recommended. The recycle flow is chosen so that the wetland cell is filled and drained 8 times per day (Austin, Lohan & Verson 2003). For that to happen, a total flow of 48,000 L is needed. This means the recycle flow should create an extra 28,000 L per day.

Figure 5.2 shows a simple sketch of the required wetland set-up.

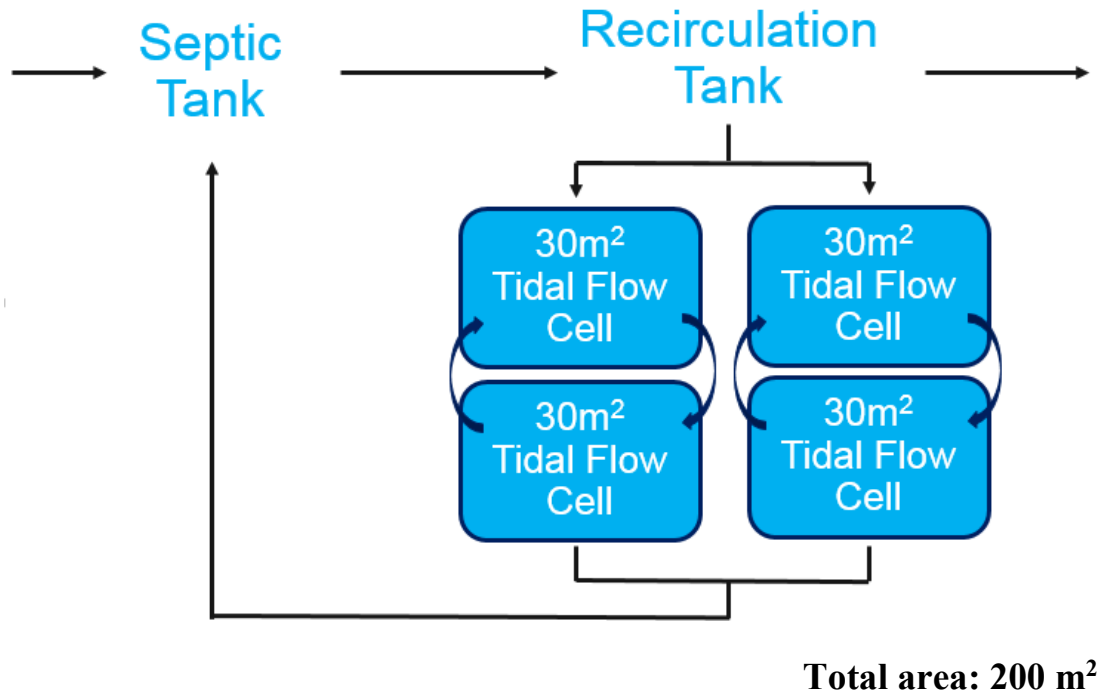

FIGURE 5.2: LAYOUT OF TIDAL FLOW WETLAND

5.4.2. Energy Use

For both wetland systems, the energy consumption needed for primary treatment is not included in the calculations.

For the tidal flow system, it is assumed that the flow through the system is by gravity through an overflow drain. This means the only energy the tidal flow system uses, is for reciprocation of the water between the cells and for the recycle flow. The reciprocation pump is used intermittently, while the recycle flow pump is constantly pumping water.

Reciprocation pumps:

The tidal flow wetland cell receives a constant inflow of 48,000 L/d (20,000 L daily inflow + 28,000 L recirculation flow per day). This equals a flow rate of 2000 L/h. During a reciprocation cycle, the reciprocation pump must move the pore volume of one cell to the other in a reciprocating pair, plus the influent it receives during the pumping phase. To allow for 8 reciprocation cycles per day and enough resting time in between pumping phases, the pumping time for reciprocation of the water between the cells should be 1 hour. This means the reciprocation pump must move the total

pore volume plus the inflow in 1hour. From this, the required pumping rate can be calculated:

$$\text{Pumping rate} = 6000 \text{ L/h} + 2000 \text{ L/h} = 8000 \text{ L/h}$$

The reciprocation pump runs for 1 hour every 3 hours, which equals a total running time of 8 hours. Due to the two wetland systems operating in parallel operation and only one system running at any one time these calculations are based on one reciprocation pump only.

To find the power consumption of the pumps Equation 4, Equation 5, Equation 6 are used. The total dynamic head is the sum of the total depth of the wetland cell and the frictional losses in the pipes etc. The total dynamic head is estimated to be 1.5m. The pump chosen is a “Zenit 40/2/G32VMGEX”. It is rated for a flow rate of 160 L/min and a max head of 4 m.

EQUATION 4: HYDRAULIC POWER (AUSTIN & NIVALA 2009)

$$P_h = \frac{q\rho gh}{3.3 * 10^6} \quad (4)$$

where P_h = hydraulic power in kW
 q = flow capacity in m³/h
 ρ = density of water (=1000 kg/m³)
 h = total dynamic head in m
 g = gravitational force (9.81 m/s²)

EQUATION 5: SHAFT POWER (AUSTIN & NIVALA 2009)

$$P_s = \frac{P_h}{\eta} \quad (5)$$

where P_s = shaft power in kW
 P_h = hydraulic power in kW
 η = pump efficiency (=0.75 (Austin & Nivala 2009))

EQUATION 6: ELECTRIC POWER REQUIREMENTS (AUSTIN & NIVALA 2009)

$$P_e = \frac{P_s}{\eta} \quad (6)$$

where P_e = electrical power in kW
 P_s = shaft power in kW
 η = motor efficiency (0.9 (Austin & Nivala 2009))

From Equation 4, 5 and 6 the required electric power is calculated to be 0.053 kW. With an operational time of 8 hours per day the daily power consumption of the reciprocation pump is 0.424 kWh/day.

Recycle flow pump:

The recycle flow pump moves water at a constant rate for 24 hours a day. Over 24 hours it moves 48,000 L which equals a flow rate of 2000 L/h.

The total dynamic head of the recycle pump is assumed to be 3 m. From Equation 4, Equation 5, Equation 6 and the 24 hour operational time per day the total power consumption of the recycle flow pump is 0.634 kWh/day

Total daily power consumption:

The total daily power consumption of the tidal flow wetland is the sum of the power consumptions of both pumps. This means the total power consumption of the tidal flow wetland is **1.058 kWh per day**.

5.5. Vertical Subsurface Flow Treatment Wetland

5.5.1. Choosing an Appropriate Treatment Wetland

There are a wide range of conventional treatment wetlands available. The main categories are surface flow, subsurface horizontal flow and subsurface vertical flow. Each of these have their advantages and disadvantages. These are explained in detail in chapter 4. To achieve total nitrogen removal (nitrification and denitrification) a staged or hybrid wetland system is necessary. A good nitrification rate can only be achieved in a VF wetland, while FWS and HSSF wetlands provide good conditions for denitrification. This means for this design exercise a VF wetland coupled with a HSSF or a FWS wetland is necessary.

Sizing of a conventional wetland is complicated and various models (Reed et al 1995, Kadlec et al 2008) have been developed for preliminary sizing of wetlands. When trying to apply these to the wastewater situation in this study, it was found that changing one parameter slightly the required wetland size changed dramatically. This meant for this hypothetical comparison study, the models were only useful if parameters, like removal rate, were known or at least able to be assumed without large error. This was not possible for most contaminants. During further research into conventional treatment wetlands for advanced wastewater treatment, the French System Vertical Flow Treatment Wetland (Molle et al. 2005) was found. Details about the French system can be found in section 4.1.2. This system combined with a FWS wetland, to complete denitrification, was chosen for the comparison study.

5.5.2. Preliminary Sizing of the Wetland Area

The French system isn't sized on influent and target effluent water quality, instead the sizing of the subsurface flow wetland filters is based on the acceptable organic load on the filter surface per person equivalent (PE). A French System SSF wetland usually consists of two stages of wetland filters. The first stage consists of 3 filters operated in parallel. This means only one of the 3 filters is operated at any one time while the other filters are being rested. The second stage consists of 2 filters in parallel operation. One filter is being loaded, while the other one is rested. The resting period of the wetland filters controls the growth of the attached biomass on the filter media. Loading the filters without allowing for resting periods would result in clogging of the filter media.

The surface area recommended per PE is (Molle et al. 2005):

- 1.2 m²/PE divided over 3 identical wetland filters for the first stage filters
- 0.8 m²/PE divided over 2 identical wetland filters for the second stage filters

For this example (100PE) this results in 5 (3 in stage 1, 2 in stage 2) identical sized wetland filters, each being 40 m².

The total area for the French System vertical SSF wetland therefore is 200 m². This setup allows for nitrification, but only partially denitrifies (for this exercise total nitrification and 50% denitrification is assumed (D. Austin 2015, pers. comm., 15th Aug). Final denitrification, and hence total nitrogen removal, is achieved by a FWS wetland. The size of the FWS wetland is determined by the first order equation in Kadlec and Wallace (2008).

The *P-k-C** Model (first order equation) (Kadlec & Wallace 2008) can be used as long as influent wastewater concentration and effluent target concentrations are known and removal rate (*k*) and apparent number of tanks in series (*P*) can be approximated without large error.

EQUATION 7: CALCULATION OF FWS WETLAND AREA A_w (KADLEC & WALLACE 2008)

$$A_w = \left[\left(\frac{C_e - C^*}{C_i - C^*} \right)^{-\frac{1}{P}} - 1 \right] \frac{PQ_{in}}{k_{AT}} \quad (7)$$

- where
- C_e = Target effluent concentration in mg/L
 - C_i = Influent wastewater concentration in mg/L
 - C^* = Irreducible background concentration in mg/L
 - k_{AT} = First-order areal rate constant in m/yr (here $k_{AT} = 100$ m/yr)
 - P = Apparent number of tanks in series
 - Q_{in} = Design flow rate in m³/d

Due to the French system only achieving 50% denitrification, the outflow of the French system wetlands flows into the FWS wetland with a nitrate concentration of around 17 mg/L. Levels for BOD, TSS, TKN and phosphorus are assumed to be at acceptable levels after treatment in the French system wetland.

To size the FWS wetland to remove the nitrate concentration to an acceptable level, the following values are used in the first order equation:

$$C_i = 17 \text{ mg/L}$$

$$C_e = 10 \text{ mg/L}$$

$$C^* = 0$$

$$P = 3 \text{ (D. Austin 2015, pers. comm., 15th Aug.)}$$

$$k_{AT} = 100 \text{ m/yr (D. Austin 2015, pers. comm., 15th Aug.)}$$

$$Q_{in} = 20000 \text{ L}$$

This results in a required area of 283 m².

Therefore the total area required to treat the initial wastewater to the required effluent standard in a passive flow treatment wetland, is 483 m². This is around 4 times the size of the tidal flow treatment wetland.

Figure 5.3 shows a simple sketch of the required wetland set-up:

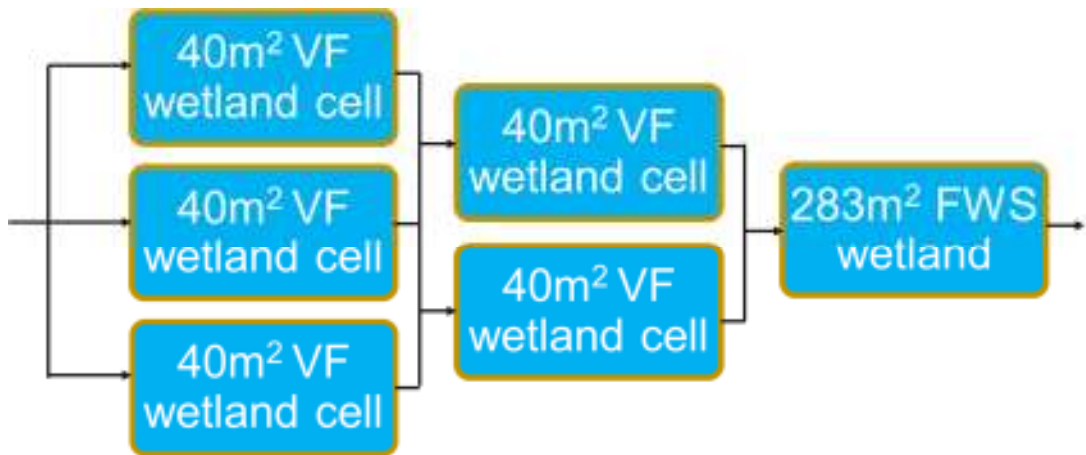

Total area: 483 m²

FIGURE 5.3: LAYOUT STAGED FRENCH SYSTEM VF WETLAND FOLLOWED BY FWS WETLAND

5.5.3. Energy Use

As mentioned earlier the energy consumption for primary treatment is ignored. For the conventional treatment wetland it is assumed that all flow through the wetland cells is by gravity. For this the wetland has to be constructed on a slope. Wetland cells are loaded by syphons. This means that this hybrid CW does not need any energy input at all.

CHAPTER 6 - RESULTS

The literature review gave a thorough and detailed overview on research and knowledge available on the topic of “Tidal Flow Wetlands”. It showed that there is a wide field of applications that can possibly be covered by TFWs. TFWs can be used as decentralised wastewater treatment and re-use systems and as standalone systems to treat high strength wastewater. The literature review suggested that they are also a promising option for low energy tertiary treatment used after conventional secondary treatment (trickling filter, activated sludge systems). Another very promising approach for TFWs is the application in remote locations and developing countries, that don't have access to highly engineered wastewater treatment systems.

The calculations and direct comparison of a hybrid CW and a TFW, in chapter 5, has shown how these two systems compare when applied to a small residential development. From the given conditions, a French system VF CW, combined with a FWS CW, was chosen to be the most efficient CW for this situation. Other hybrid CW are possible options, but removal rates for each contaminants were impossible to predict accurately. Other type systems would most likely end up being much larger in size than the chosen French system.

For the given wastewater situation, the TFW required 120 m² for achieving the given tertiary treatment standard. The hybrid CW required a total area of 484 m². This area was made up of a 200 m² French system and a 284 m² FWS CW. The FWS CW was designed to complete denitrification to achieve TN removal. A high nitrate removal rate of 100 m/y was assumed, due to the location of the wetland in a subtropical climate, such as South East Qld. In a colder climate, this nitrate removal rate can be as low as 15 m/y, which would dramatically increase the size of the FWS wetland.

The hybrid CW was designed to work without any energy input at all. For this the complete system would have to be installed on a suitable slope. To keep conditions comparable, it was assumed that flow through the TFW was by gravity also, and energy input was only required for the reciprocation of the wastewater between the wetland cells and the required flow recirculation of the system. This means the TFW would also have to be installed in a way that accommodates the flow by gravity through the system. The total energy input needed for the TFW was calculated to be 1.058 kWh per day. This energy use is comparable to around 4-5 standard (15 W) energy saving lightbulbs used for 24 h/day.

From the calculations, it was clear that the TFW required the 120 m² of area due to the BOD load. TN removal was able to be achieved on just 12 m³, which with a depth of

0.5 m, would only require 24 m² land area. This area can again be reduced by using an aggregate with a high CEC such as a lightweight expanded shale aggregate.

By comparison, the hybrid wetland system needed a size of 200 m² to achieve sufficient BOD, TSS and ammonia removal. This area only included partial denitrification. Just to complete the denitrification process, an additional area of 284 m² was required. This means that for BOD the wetlands are comparable in size and only the TN removal causes the large gap in area requirements. This again confirms that especially for TN removal TFWs have a large advantage in the size needed to achieve advanced levels.

Previous studies show that tidal flow wetlands can remove TN using only a quarter of the energy required by a comparable activated sludge systems.

CHAPTER 7 - CONCLUSION

This study has highlighted that TFWs are a very promising approach for wastewater treatment in the future. TFWs can close the gap between highly engineered, high energy wastewater treatment systems and low maintenance natural treatment systems such as CWs that require minimal to no energy input.

The unique TN removal ability makes these systems a suitable option for situations like:

- Remote locations and underdeveloped countries, due to the low maintenance required on these systems and being able to be built out of locally available materials
- Small communities, due to their ability to treat very small loads of wastewater
- Nitrogen removal to achieve advanced treatment levels after secondary treatment by an activated sludge systems, reducing energy usage significantly
- As a stand-alone decentralised wastewater treatment and re-use system for large office buildings and institutions, when coupled with a water polishing unit
- Wastewater treatment and re-use system for agricultural areas, to reduce potable water usage for irrigation
- Treatment of high strength nitrogen wastewater

Further studies, especially pilot systems, are required to confirm these findings.

APPENDIX A - PROJECT SPECIFICATIONS

FOR: Ina Weinheimer

TOPIC: Water Treatment using Constructed Wetland – Tidal Flow Wetlands

SUPERVISOR: Prof Jochen Bundschuh

ENROLMENT: ENG 4111 – S1 2015 External
ENG 4112 – S2 2015 External

PROJECT AIM: To evaluate the applicability of Tidal Flow Wetlands as a wastewater treatment option

PROGRAMME:

1. Research history of constructed wetlands for wastewater treatment
2. Research and identify contaminants occurring in wastewater
3. Research and identify the wastewater treatment process and contaminant removal mechanism involved in constructed wetlands (focus on tidal flow wetlands)
4. Critically analyse and evaluate different constructed wetland systems and other wastewater treatment systems compared to tidal flow wetlands
5. Set up a performance comparison of a tidal flow wetland and a conventional treatment wetland to be able to directly compare treatment outcomes and design methods for a specific wastewater situation
6. Discuss findings, evaluate positive and negative features, suitability and limitations of Tidal Flow Wetlands
7. Conclusion and future outlook
8. Submit dissertation on the research

REFERENCES

Austin, D 2003, *Advanced Treatment Wetlands: A 4th Generation Technology*, White Bear Lake, Minnesota, USA.

Austin, D 2006, 'Influence of cation exchange capacity (CEC) in a tidal flow, flood and drain wastewater treatment wetland', *Ecological Engineering*, vol. 28, no. 1, pp. 35-43, <<http://www.sciencedirect.com/science/article/pii/S0925857406000723>>.

Austin, D & Nivala, J 2009, 'Energy requirements for nitrification and biological nitrogen removal in engineered wetlands', *Ecological Engineering*, vol. 35, no. 2, pp. 184-92.

Austin, D, Lohan, E & Verson, E 2003, 'Nitrification and Denitrification in a Tidal Vertical Flow Wetland Pilot', in *Water Environment Technical Conference: proceedings of the Water Environment Technical Conference Los Angeles*.

Behrends, LL 1999, *Reciprocating Subsurface-Flow Constructed Wetlands for Improving Wastewater Treatment*, 755858, Tennessee Valley Authority United States Corp., USA.

Behrends, LL & Lohan, E 2012, 'Tidal-Flow Constructed Wetlands: The Intersection of Advanced Treatment, Energy Efficiency, Aesthetics and Water Reuse'.

Hoffmann, DH, Platzer, D-IC, Winker, D-IM & Muench, DEv 2011, *Technology review of constructed wetlands, Subsurface flow constructed wetlands for greywater and domestic wastewater treatment*, Eschborn,<

<http://sustainablewater.com/ recip-reciprocating-wetlands/>, 2015, viewed 1/06/2015, <<http://sustainablewater.com/ recip-reciprocating-wetlands/>>.

<http://www.livingmachines.com>, 2015, viewed 1/06/2015, <<http://www.livingmachines.com/Home.aspx>>.

Kadlec, RH 1995, *Treatment wetlands*, Lewis Publishers, Boca Raton.

Kadlec, RH & Wallace, S 2008, *Treatment Wetlands, Second Edition*, CRC Press.

Knowles, P, Dotro, G, Nivala, J & García, J 2011, 'Clogging in subsurface-flow treatment wetlands: Occurrence and contributing factors', *Ecological Engineering*, vol. 37, no. 2, pp. 99-112, <<http://www.sciencedirect.com/science/article/pii/S0925857410002600>>.

Lee, C-g, Fletcher, TD & Sun, G 2009, 'Nitrogen removal in constructed wetland systems', *Engineering in Life Sciences*, vol. 9, no. 1, pp. 11-22, <<http://dx.doi.org/10.1002/elsc.200800049>>.

Li, C, Wu, S & Dong, R 2015, 'Dynamics of organic matter, nitrogen and phosphorus removal and their interactions in a tidal operated constructed wetland', *Journal of Environmental Management*, vol. 151, no. 0, pp. 310-6, <<http://www.sciencedirect.com/science/article/pii/S0301479715000195>>.

Liu, M, Wu, S, Chen, L & Dong, R 2014, 'How substrate influences nitrogen transformations in tidal flow constructed wetlands treating high ammonium wastewater?', *Ecological Engineering*, vol. 73, pp. 478-86, <<http://www.sciencedirect.com/science/article/pii/S0925857414005229>>.

Molle, P, Lienard, A, Boutin, C, Merlin, G & Iwema, A 2005, 'How to treat raw sewage with constructed wetlands: an overview of the French systems', *Water Science & Technology*, vol. 51, no. 9, pp. 11-21.

Monjeau, C 1901, *Purifying water*, 40,341, USA, 3/09/1901.

Nivala, J, Wallace, S, Brix, H, Headley, T, Kassa, K, Afferden, Mv & Müller, R 2012, *Conventional and intensified subsurface flow treatment wetlands: Comparative analysis using the P-k-C* model*.

Nivala, J, Headley, T, Wallace, S, Bernhard, K, Brix, H, Afferden, Mv & Müller, RA 2013, 'Comparative analysis of constructed wetlands: The design and construction of the ecotechnology research facility in Langenreichenbach, Germany', *Ecological Engineering*, vol. 61, Part B, no. 0, pp. 527-43, <<http://www.sciencedirect.com/science/article/pii/S0925857413000566>>.

Nivala, J, Wallace, S, Headley, T, Kassa, K, Brix, H, Afferden, Mv & Müller, R 2013, 'Oxygen transfer and consumption in subsurface flow treatment wetlands', *Ecological Engineering*, vol. 61, Part B, no. 0, pp. 544-54, <<http://www.sciencedirect.com/science/article/pii/S0925857412002881>>.

Sun, G, Gray, KR, Biddlestone, AJ & Cooper, Dj 1999, 'Treatment of Agricultural Wastewater in a Combined Tidal Flow-Downflow Reed Bed System', *Water Science and Technology*, vol. 40, no. 3, pp. 139-46.

Sun, G, Zhao, Y, Allen, S & Cooper, D 2006, 'Generating "Tide" in Pilot-Scale Constructed Wetlands to Enhance Agricultural Wastewater Treatment', *Engineering in Life Sciences*, vol. 6, no. 6, pp. 560-5, <<http://dx.doi.org/10.1002/elsc.200620156>>.

Tilley, E, Ulrich, L, Lüthi, C, Reymond, P & Zurbrügg, C 2014, *Compendium of Sanitation Systems and Technologies*, Swiss Federal Institute of Aquatic Science and Technology (Eawag), Duebendorf, Switzerland.

Vohla, C, Kõiv, M, Bavor, HJ, Chazarenc, F & Mander, Ü 2011, 'Filter materials for phosphorus removal from wastewater in treatment wetlands—A review', *Ecological Engineering*, vol. 37, no. 1, pp. 70-89, <<http://www.sciencedirect.com/science/article/pii/S0925857409002419>>.

Vymazal, J 2007, 'Removal of nutrients in various types of constructed wetlands', *Science of the Total Environment*, vol. 380, no. 1–3, pp. 48-65, <<http://www.sciencedirect.com/science/article/pii/S0048969706007212>>.

Vymazal, J 2010, 'Constructed Wetlands for Wastewater Treatment', *Water (Basel)*, vol. 2, no. 3, pp. 530-49.

Wallace, S, Higgins, J, Crolla, A, Kinsley, C, Bachand, A & Verkuyl, S 2006, 'High-Rate Ammonia Removal in Aerated Engineered Wetlands', in *10th International Conference on Wetland Systems for Water Pollution Control: proceedings of the 10th International Conference on Wetland Systems for Water Pollution Control* Lisbon, Portugal.

Wu, S, Zhang, D, Austin, D, Dong, R & Pang, C 2011, 'Evaluation of a lab-scale tidal flow constructed wetland performance: Oxygen transfer capacity, organic matter and ammonium removal', *Ecological Engineering*, vol. 37, no. 11, pp. 1789-95, <<http://www.sciencedirect.com/science/article/pii/S0925857411002138>>.

Wu, S, Kusch, P, Brix, H, Vymazal, J & Dong, R 2014, 'Development of constructed wetlands in performance intensifications for wastewater treatment: A nitrogen and organic matter targeted review', *Water Research*, vol. 57, no. 0, pp. 40-55, <<http://www.sciencedirect.com/science/article/pii/S0043135414002103>>.

Zhao, YQ, Sun, G & Allen, SJ 2004, 'Anti-sized reed bed system for animal wastewater treatment: a comparative study', *Water Research*, vol. 38, no. 12, pp. 2907-17, <<http://www.sciencedirect.com/science/article/pii/S0043135404001745>>.

Zhao, YQ, Zhao, XH & Babatunde, AO 2009, 'Use of dewatered alum sludge as main substrate in treatment reed bed receiving agricultural wastewater: Long-term trial',

Bioresource Technology, vol. 100, no. 2, pp. 644-8,
<<http://www.sciencedirect.com/science/article/pii/S0960852408006391>>.

Zhao, YQ, Babatunde, AO, Hu, YS, Kumar, JLG & Zhao, XH 2011, 'Pilot field-scale demonstration of a novel alum sludge-based constructed wetland system for enhanced wastewater treatment', *Process Biochemistry*, vol. 46, no. 1, pp. 278-83,
<<http://www.sciencedirect.com/science/article/pii/S135951131000334X>>.

Zhi, W, Yuan, L, Ji, G & He, C 2015, 'Enhanced long-term nitrogen removal and its quantitative molecular mechanism in tidal flow constructed wetlands', *Environmental Science and Technology*, vol. 49, no. 7, pp. 4575-83,
<<http://dx.doi.org/10.1021/acs.est.5b00017>>.